

DEHUMIDIFIER

MODEL

MJ-E23AX-A

INSTRUCTION MANUAL

Features

- 2 types of laundry mode
- Independent air purifying function
- Bathroom mildew guard



- In order to ensure correct usage, please read this instruction manual carefully and retain it for future reference.
- Before accepting the Warranty at the time of purchase, please make sure that the date of purchase, place of purchase and other items are correctly filled in the form.

Table of Contents page

● Recommended Ways of Using the Unit	2	Before Using the Unit
● Precautions	3	
● Warning	5	
● Tips on Dehumidification	5	
● Features of This Dehumidifier	6	
● Names and Functions of Parts	7	
Front/Back Control Panel/LCD Display	7 8	
● Auto Power-off Function	8	Operating
● Before Using Your Dehumidifier	9	
● Carrying the Unit	9	
● Drying Laundry	10	
INTELLIGENT LAUNDRY/NIGHT LAUNDRY		
● Dehumidifying	12	
EASY/AUTO/HIGH/LOW/MILDEW GUARD		
● Cleaning the Air (AIR PURIFIER)	15	
● Replacement Parts	15	
● Using Child Lock	15	
● Using Louvre	16	
● Using Timer	17	
OFF TIMER operation/ON TIMER operation		
● Drying Inside Operation	18	
● Draining	19	
● Continuous Drainage	20	
● Maintenance	21	Troubleshooting
● Storage	21	
● Troubleshooting	22	
● Specifications	Back cover	
● Disposal	Back cover	

- This appliance is not intended for users (including children) with insufficient physiological, sensory or mental capabilities or the lack of experience or knowledge, unless it is used under the supervision or instruction of a qualified safety personnel.
- Children should be supervised to ensure that they do not play with the appliance.
- If the power cord is damaged, it must be replaced by the manufacturer, its services agent or any suitably qualified electrical person in order to avoid a hazard.

Recommended Ways of Using the Unit

When you want to dry laundry

When you want to perform automatic operation

● **INTELLIGENT LAUNDRY** ▶ P.10

Reducing blowing sound and performing automatic operation

● **NIGHT LAUNDRY** ▶ P.10

When you want to perform continuous operation

● **HIGH** ▶ P.12-13



Tips on Drying Laundry
P.11

When you want to dehumidify ▶ P.12-13

When you want to set the humidity

● **AUTO**

When you want to perform continuous operation

● **HIGH**

When you want to perform automatic operation

● **EASY**

Reducing blowing sound and performing continuous operation

● **LOW**

When you are worried about mildew in the bathroom

● **MILDEW GUARD** ▶ P.12-14

When you want to clean the air

● **AIR PURIFIER** ▶ P.15

Frequently Asked Questions

Q. Why is there still condensation on the windows in the morning?

A. The dehumidifier can take a few weeks to reduce the moisture in your home to an acceptable level. This is best done by setting the unit to High. We also recommend the unit be moved from room to room. After this initial few weeks the unit can then be set to one of the auto modes 50~70 and this will maintain the Humidity to your desired level. On cold mornings there may still be a small amount of condensation on the windows.

Q. Can I leave my Dehumidifier turned on 24 hours a day?

A. No problem. The unit can be left running unattended. It will switch off automatically when the tank gets full or the required humidity is reached. Note that when operating in the EASY, AUTO, HIGH, or LOW mode, the unit will automatically stop after 12 hours have elapsed since the last operation in order to prevent forgetting to turn the power off.

Precautions

The following diagrams indicate circumstances where danger can result from mishandling the unit.



WARNING

Mishandling may result in fatal or serious injuries.



CAUTION

Mishandling may result in minor injuries or damage to your home or property, etc.



Forbidden



Do not disassemble



Keep away from fire



Do not subject to water



Always follow the instructions



WARNING

Do not damage or modify the power cord or plug. Do not use power sockets in which the plug fits loosely.

Do not modify, bundle, twist, bend or heat the power cord. Do not place under objects or use with the end close to the plug bent. (Keep pets from biting the cord.)

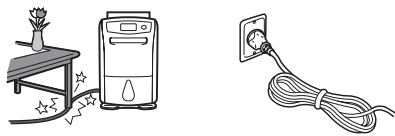

The cord may be damaged **resulting in fire, electric shock or heat generation.**

Do not use extension cords or multiple head adapters.

This may **result in fire or electric shock.**



Do not start/stop the unit by plugging/unplugging the power cord.

This may **result in fire and/or electric shock.**



Do not put the unit near heat-generating devices (such as stoves, fan heaters, etc.).

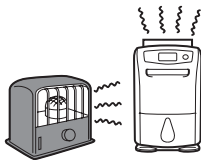

The plastic parts may melt and **cause fire.**

Do not put your fingers or any long object, into the air intake/outlet. Do not touch the swing louvre.



The internal fan rotates at high speeds, and such actions may **result in injury.**

Do not attempt to repair, disassemble, or modify the unit.

This may **result in fire and/or electric shock.** See the last page for service contact details.



Exclusively use 230-240 V AC power sockets for the power supply.

Failing to do so may **result in a fire and/or electric shock.**

* Use an extension cord by itself.



Wipe dust off the power plug and insert the plug firmly.

If the plug is not fully inserted into the socket, dust may gather on the connectors which may **cause fire and/or electric shock.**



Should abnormal symptoms occur (a burning smell, water leaking from the main body, etc.), switch off the unit and unplug it from the socket.

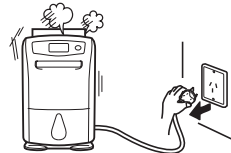

Continuing to operate the unit may **result in fire or electric shock.**

See the last page for service contact details.

Remove water that has collected in the tank.

Accidentally drinking the water or using it for other purposes may **cause illness and/or unforeseen accidents.**



CAUTION

Do not cover an air outlet or air intake with laundry, cloth, curtain, etc.

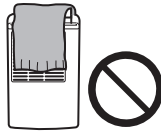

This results in poor ventilation and may **cause heat generation/fire**.

Do not put vases or any other objects filled with water on the unit.

Water may leak into the unit adversely affecting electric insulation and **cause electric shock and/or fire** by short-circuiting.

Do not use the unit in a bathroom or other location where it is likely to come into contact with water, or wash it with water.



Exposure to water may **result in fire or electric shock** caused by an electric leak.

Do not use the unit where it may be exposed to direct sunlight or other weather conditions. (This unit is for indoor use only.)



This may **cause overheating, electric shock and/or fire** caused by an electric leak.

Do not use the unit in narrow, enclosed places such as inside closets, between pieces of furniture, etc.

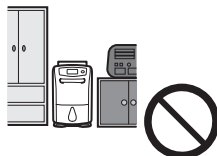

This results in poor ventilation and may **cause heat generation and/or fire**.

Do not use combustion appliances in the path of the air outlet.

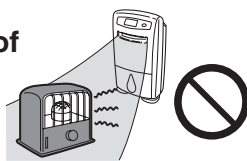

This may **cause incomplete combustion** in the appliance.

Do not use the unit in places that may be subject to oil or flammable gas leakage.

Such a leak around the unit may **cause combustion and fire**.
In addition, chemicals and solvents evaporated in the air may deteriorate the unit (crack the main body) and cause water in the tank to leak, **resulting in damage to property**.

Do not use the unit in places where chemicals are used (such as hospitals, factories, laboratories or beauty salons).

Chemicals and solvents evaporated in the air may harm the unit and cause water in the tank to leak, **resulting in damage to property**.

Do not use the unit for special purposes, such as preservation of food, art or scientific works.



This may **negatively affect the quality** of the items stored.

Do not point airflow from the unit directly at the body for a prolonged period of time.

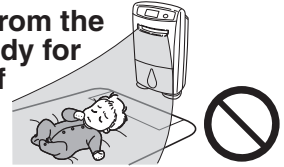

Be especially careful when using the unit where there is someone who is unable to adjust the humidity (infant, child, or elderly person).

If air-flow is directed at the body for long periods, it may **harm one's physical condition and lead to dehydration**.

Do not stand on, sit on or lean against the unit. Do not pull the unit by the downward air outlet.

As the unit is on wheels, it may move, tip over, or fall **causing personal injury**.

Do not remove the Styrofoam from the floating element.

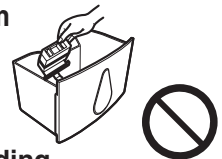

The floating element will not be able to detect a full tank resulting in water leakage, **which may damage surrounding objects or cause electric shock and/or an electric leak**.

Do not drain water continuously if there is a possibility that temperature around the hose could drop to freezing point.

Water inside the hose may freeze and prevent the water in the tank from flowing out. The water may leak from the unit and **damage surrounding objects**.

Install the unit in a location where the floor is flat and stable.

If the unit falls over, the water collected in the water tank may leak **damaging surrounding objects and in turn result in fire or electric shock caused by an electrical leak**.

Before moving the unit always switch it off, unplug it and remove water from the water tank.

Moving the unit with water in its tank may cause the water to leak and **damage the surrounding objects and in turn result in electric shock and/or an electric leak**.

After emptying the tank, transport the unit by grasping the handle firmly.

Losing your footing while carrying the unit may **cause personal injury or damage to the floor**.



CAUTION

Grasp the plug and remove from the power socket.

When removing the plug from the power socket, do not pull on it diagonally or by the cord as this may cause the projections/wiring to be damaged **resulting in a short circuit, electric shock or fire.**



Switch the unit off and unplug from the power source when cleaning it.

When the unit is on, the internal fan rotates at high speeds and may **cause injury.**



Unplug the unit from the power source when not using the unit for an extended period of time.

Otherwise it may **cause fire and/or electric shock** caused by an electric leak.



When draining water continuously or left unattended for long periods, inspect the unit every two weeks.

When the filter or hose is clogged with foreign materials or dirt, **the dehumidification operation is disabled and may cause leakage.**



When using the continuous drainage outlet, make sure to position the hose so that the water drains without obstruction.

The water in the tank may leak and **damage surrounding objects.**



Use the unit with caution in rooms where the walls, furniture and art work are vulnerable to dry air, as it may cause cracks and warping.



Warning

● Keep the unit always in an upright position.

Inclining the unit may cause water in the tank to leak into the unit, **resulting in malfunction.** Should you incline the unit accidentally, contact service number on the last page for advice.

Tips on Dehumidification

Drain the water tank before use.

The water tank will become full after around 4 hours. (When the room temperature is 30°C and relative humidity is 80%. Varies under actual usage environments.)

To perform continuous drainage, connect a hose before use. P20

Close the door and windows during operation.

Drying laundry

- Remove water from the laundry.
- Pull to remove any wrinkles on the laundry.
- Use swinging louvre to blow air to the laundry.
- Keep enough space between the laundry to allow air to pass through.

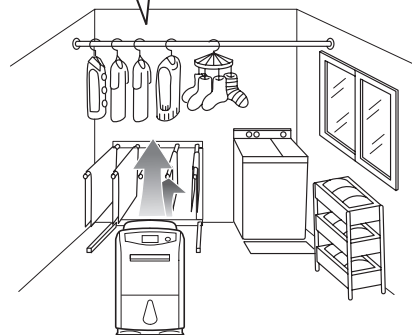

Use the dehumidifier in a small enclosed room.

In winter, drying becomes easier if you also use a heater to raise the room temperature to approximately 16°C or more.

- Drying times will vary depending on the type of the laundry and the room temperature. The low temperature may double the drying time of normal temperature. (Low temperature means approx. 10°C while normal temperature means above 20°C.)
- The strong airflow is blown from the top right point of the unit.

Installing your dehumidifier

Make sure to leave some space around the unit to ensure good results.

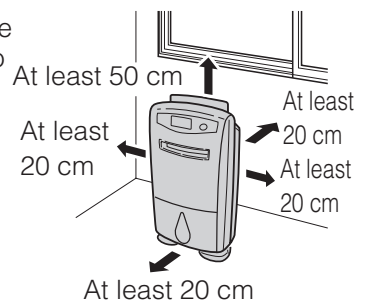

Operating noise

Place the unit on top of a mat. This reduces vibration and noise. It also prevents leaving depressions on carpets.

● Do not carry or store the unit horizontally.

This may **result in malfunctions.** Such malfunctions are NOT covered under warranty.

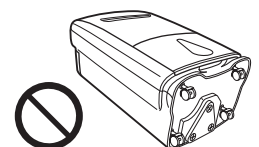

Features of This Dehumidifier

● Room temperature may rise 2–4°C during operation.

The dehumidifier does not have a cooler function. Due to heat produced during operation, the room temperature may rise 2–4°C. As a result, the unit may blow warm air, but this is not due to a malfunction. (During winter, the air may not feel warm as the temperature is below body temperature.)

How does the dehumidifier work?

If you pour cold water into a cup, the air around it becomes cold, causing water droplets to form on the surface of the cup. The dehumidifier takes advantage of this phenomenon to remove moisture from the air.

- ① The unit draws air from the room, cools it with its cooling coil, causing the moisture to transform into water droplets.
- ② The water droplets fall into the water tank.
- ③ **Dehumidified air is heated by the re-heating coil, and then blown out.**

The humidity of the room is thus reduced by repeating the above steps.

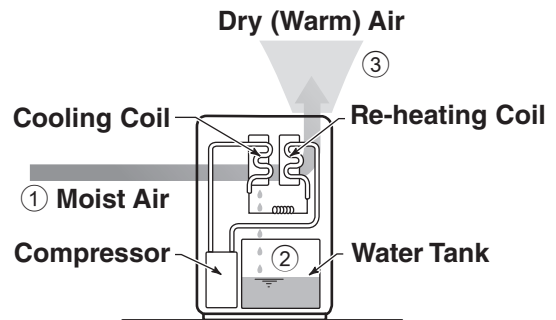

● The unit can operate in a room temperature range of 5–35°C.

If the room temperature exceeds 35°C, the unit may operate in blower mode or increase the airflow. This is because the temperature within the unit rises causing the protection mechanism to operate. In order to lower the internal temperature of the unit, use the unit with the swing stopped and louvre vertical.

- If the temperature is below 5°C, only the blower is operational to prevent the extracted water freeze.

● The humidity reading on the unit may differ from a hygrometer in the same room.

Even in the same room, temperature and humidity levels may differ from place to place. If the hygrometer and the unit are in different parts of the room, the humidity levels are prone to differ. Moreover, humidity levels differ between places that have good and no airflow.

Use the reading on the unit as an estimate.

<Cause>

1. Inconsistencies in temperature and humidity
2. Difference in location
3. Difference in hygrometer precision

● The amount of dehumidifying becomes less in winter.

When the temperature and humidity are low, the amount of water collected is decreased.

In winter, because the temperature is lower than in summer, the effect of the dehumidifier is greatly reduced as shown in the graph below. Although only a little water collects in the tank, this is not a malfunction.

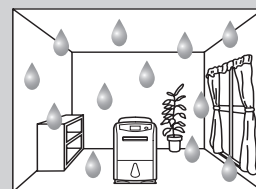

Summer (humidity)

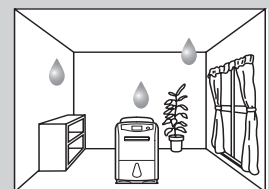

Winter (dampness)

Value for HIGH when humidity is 80%

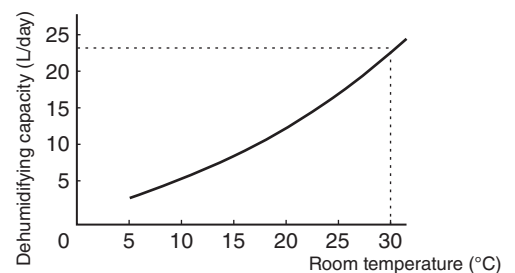

- The values shown on the graph were measured at constant temperature and humidity and do not reflect values obtained in actual usage conditions.
- The amount of dehumidifying varies depending on the operation mode.

● Defrosting operation

When the room temperature drops to about 15°C, defrosting operation starts.

The operation runs every 60 minutes. Compressor stops, airflow is delivered and the melted frost then drips into the water tank.

Names and Functions of Parts

Front

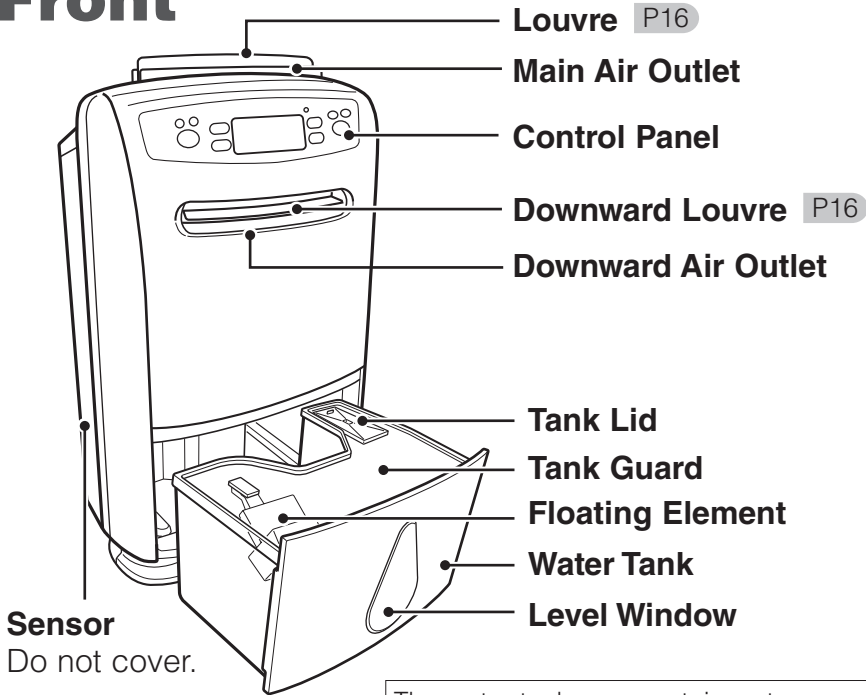

The water tank may contain water residue at time of purchase. This is from final product testing at the factory and is not due to a defect.

NOTE

It is impossible to remove the back panel because the two places shown are tightened with two special screws. If the unit has any malfunctions, contact your Mitsubishi dealer.

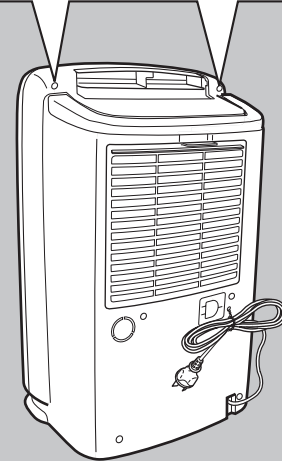

Back

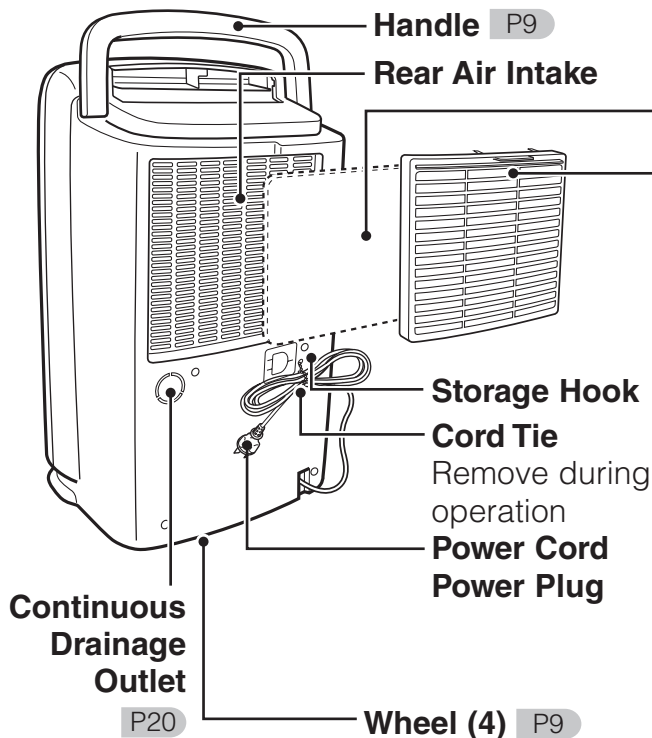

Accessory

● Silver ion filter

Silver ion filter is supplied with the unit at the time of purchase. Set it before use. P9

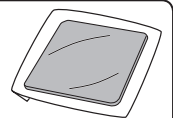

Silver ion filter for replacement P15

What is the silver ion filter?

The silver ion filter has a two-layer construction consisting of a white particle filter and a blue air freshener filter.

<Particle filter>

The fine particle filter removes pollen* and dust particles.

* Diameter of pollen: approx. 10–100 μm

<Air freshener filter>

A special deodorant and anti-bacterial agent (antiallergen, anti-virus and sterilization) are contained in the fibres of the silver ion filter. Cigarette smoke and toxins found in smoke, such as carbon monoxide, cannot be removed with this filter.

Names and Functions of Parts (Cont.)

Control Panel

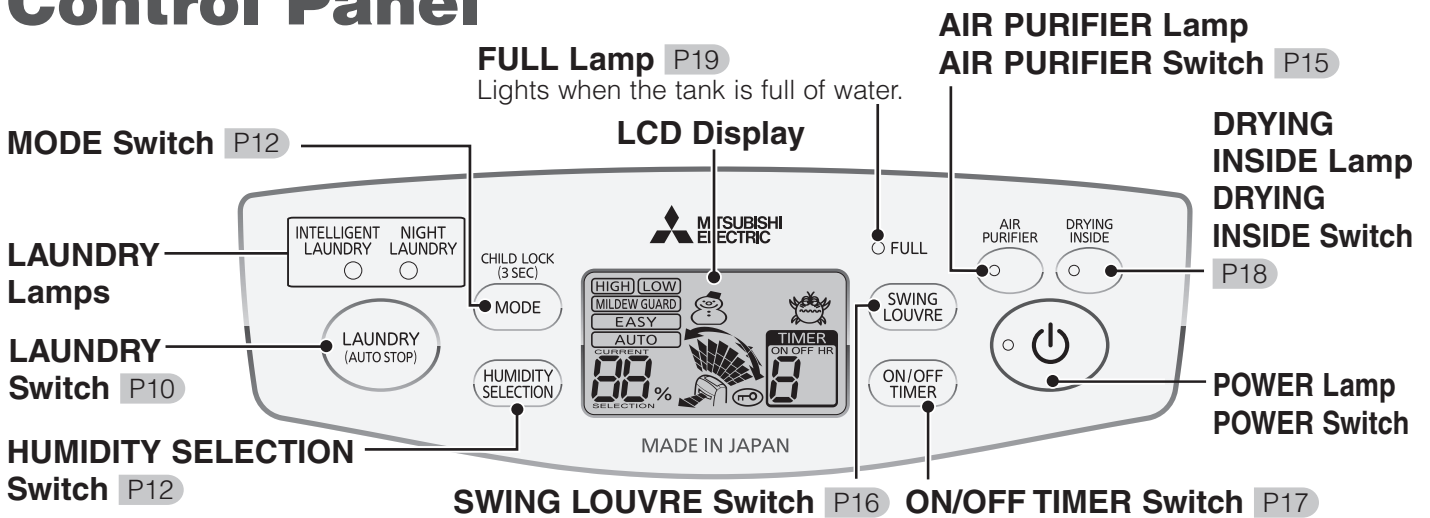

- Information**
- The dehumidifier remembers the operation mode. Even if the power plug is disconnected or the power is turned off, the unit restarts at the previous setting.
 - In the case of a power outage during operation, the dehumidifier will restart operation upon restoration in the operation mode before the power outage.

LCD Display

Operating Mode Indicator P12-14

- All of the indicators on the LCD display are shown for explanation purposes.
- When any switch is pressed, the LCD backlight will turn on for approximately 10 seconds.

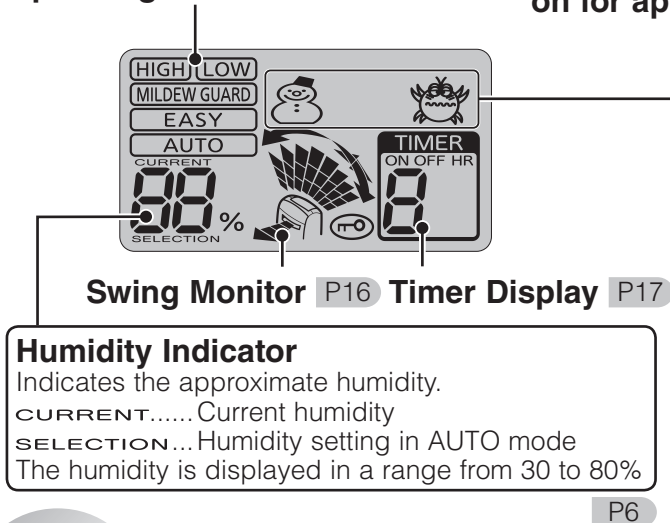

Auto Power-off Function

- When operating in the EASY, AUTO, HIGH, or LOW mode, the unit will automatically stop after 12 hours have elapsed since the last operation in order to prevent forgetting to turn the power off.
- When starting operation again, empty the water tank before pressing the POWER switch.

Information If the DRYING INSIDE (auto) operation has been activated, the DRYING INSIDE operation will start after the unit stops. P18

Switching the Auto Power-off Function Setting

If you want to operate the unit continuously for 12 hours or more, turn OFF the auto power-off function.

While the power is off.



Press and hold for at least 3 seconds until a sound is made

- **When the auto power-off function is switched to OFF**
A "blip" sound is made and the humidity indicator shows "OF".
- **When the auto power-off function is switched to ON**
A "blip blip" sound is made and the humidity indicator shows "ON".

* The default setting is "ON".

Before Using Your Dehumidifier

Setting the silver ion filter

The silver ion filter is supplied with the unit at time of purchase. Please install it before using the unit.

- 1 Remove the silver ion filter from the polyethylene bag.
- 2 Remove the pre-filter.

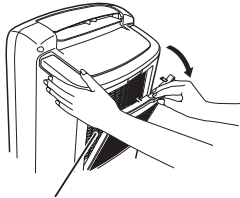

Pull the pre-filter toward you, and then remove it.

Performance is unaffected even if the metal fin inside the unit are slightly bent.

- 3 Set the silver ion filter.

With the strips facing up, set the silver ion filter inside the tabs on the pre-filter.

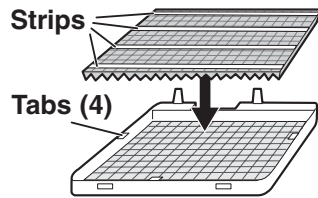

- 4 Set the pre-filter.

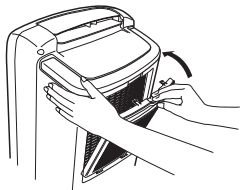

Insert the bottom tabs into the unit until they click.

Note

Make sure the silver ion filter is attached to the unit. If it is not, fine dust will enter inside the unit and cause a malfunction.

Inserting the water tank correctly

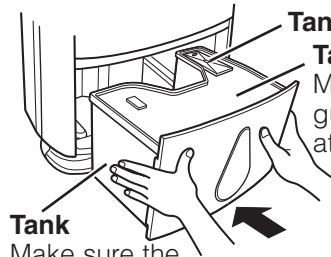

Tank Lid

Tank Guard

Make sure the tank guard is securely attached.

Tank

Make sure the tank is not broken or cracked.

Note

Secure the tank lid and tank guard properly or else the tank may become stuck.

Plugging the power cord into the power socket

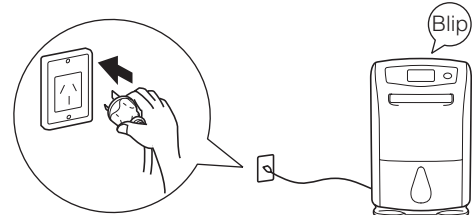

Use a 230-240V AC power socket only.

- The current humidity is indicated.

If the louvre is open, it closes automatically.

Before Using the Unit

Carrying the Unit

Hold the handle and move it.

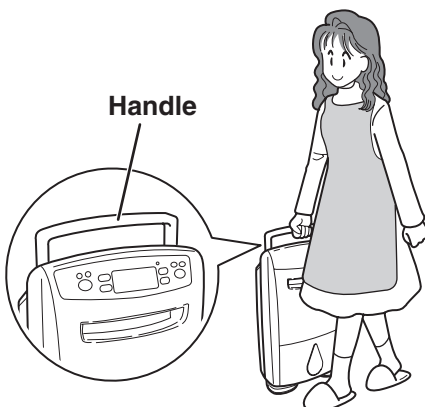

Handle

Wheels can be used to move the unit.

First make sure to remove water from the water tank and close the louvre before carrying the unit.

- If wheels are unable to roll smoothly, do not use excessive force to move this unit so as to prevent overturning.
- Do not carry the unit by holding the downward louvre.
- Do not put the unit in horizontal position during carrying as this may cause malfunctions.
- Use wheels to move the unit steadily in one direction.
- Lift the unit up to go over the doorsill or stairs and do not use wheels to move the unit over the shaggy carpet as this may damage the carpet.
- Do not allow the power cord to be pulled into the wheels, as this may damage the cord.

Note

Drying Laundry

When in the operation of INTELLIGENT LAUNDRY or NIGHT LAUNDRY, the unit will estimate the laundry drying time and stop automatically.

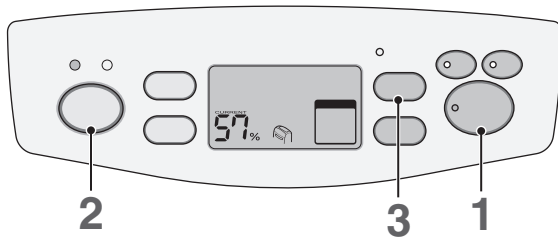

1 Press  

- POWER lamp lights.
- The operation mode is displayed.
- Louvre opens, and blows air.

2 Press , and select the laundry mode.

- Laundry mode changes with each press.

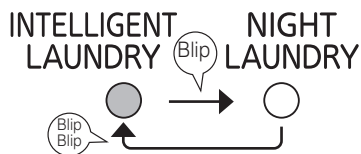

Information It is impossible to preset humidity when in INTELLIGENT LAUNDRY or NIGHT LAUNDRY mode. In INTELLIGENT LAUNDRY or NIGHT LAUNDRY mode, press HUMIDITY SELECTION switch to change into AUTO mode. **P12**

3 Press  and select the swing direction. **P16**

<To stop operation>

Press  

- POWER lamp goes out.
- The laundry mode indicator goes out.

Information If the DRYING INSIDE (auto) operation has been activated, the DRYING INSIDE operation will start after the unit stops. **P18**

Information

- After the unit stops or the power plug is inserted, the compressor will not be activated (for compressor protection). The dehumidifier will begin to work in 3 minutes after pressing the POWER switch. The noise emitted from the unit will become louder when the unit begins to dehumidify.
- The dehumidifier remembers the operation mode. Even if the power plug is disconnected or the power is turned off, the unit restarts at the previous setting.

<LAUNDRY (Automatic Stop)>

The unit controls the airflow rate while monitoring the humidity in the room, and then estimates the laundry drying time and stops automatically.

Operation time is approximately 1 hour and can be up to approximately 12 hours.

● INTELLIGENT LAUNDRY

It is recommended for shortening the laundry drying time.

● NIGHT LAUNDRY

It is recommended for reducing the noise emitted from the unit.

The drying time is longer than that of INTELLIGENT LAUNDRY.

(The unit stops dehumidifying when the water tank becomes full, and the blower begins to operate.)

Operating each operation mode

Operation mode	Automatic stop
INTELLIGENT LAUNDRY	○ (Operates for 1 to 12 hours)
NIGHT LAUNDRY	○ (Operates for 1 to 12 hours)

Information

- Remove the water from the tank before operating the unit.
The unit may stop operating when the tank is full before the laundry is dry.
- When it is used with the OFF TIMER operation mode, the unit may stop operating before the laundry is dry. **P17**
- If the room temperature is approximately 5°C or less, it becomes difficult for water to evaporate from the laundry, and the operation will stop in around 1 hour.
At this time, please use the HIGH operation mode.

Tips on Drying Laundry

Make full use of the laundry drying operation to shorten the laundry drying time.

How to Hang Clothes

- Pull to remove any wrinkles on the laundry.
- Properly space the laundry for better ventilation (approximately 5 cm between the laundry).
- Hang out the laundry which is difficult to dry to the place with good ventilation.

The drying time for the thicker parts of the laundry is probably longer.

<The following conditions will cause longer drying time>

- The laundry is of a large volume.
- The room temperature is lower. P5
When the temperature is low (approximately 10°C), the drying time is twice as long as that at normal temperature (approximately 20°C).
- The room is big.

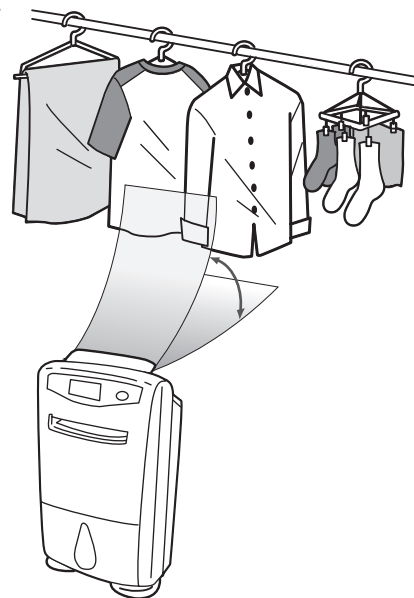

Placing the Dehumidifier

- Place the dehumidifier so that its back faces the laundry.
Air blows from the top of the dehumidifier towards the back.

How to Blow Air at Clothes

- Use swinging louvre to send air all over the laundry. P16
The drying time of the part where the air cannot reach is longer.
- The laundry is of a large volume.
Shift the position of the laundry during drying so that each part can get the blowing air.

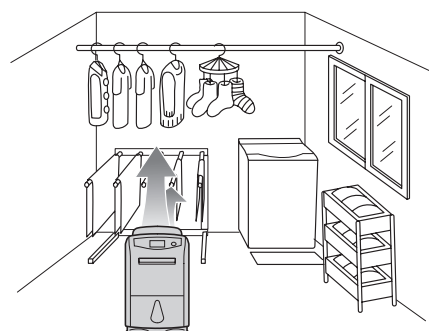

About the Room for Hanging Clothes

- In a small room, it is recommended that the door and window be closed before dehumidifying.
It is effective not only to dehumidify, but also to dry the laundry as soon as possible.
- When the room temperature is low such as in winter
Use a heater in combination with the dehumidifier in order to raise the room temperature to approximately 16°C or more, so that it is easy to dry the laundry.

Using the unit to dry clothes hung in a room is recommended on days such as the following.

● Cloudy and rainy days



During the days of high humidity weather, the laundry will take a long time to dry.

● Days with a lot of pollen and dust in the air



Drying the laundry indoor can prevent pollen particles and other dirt from attaching to the laundry.

● Days you are unable to bring in the laundry during daylight hours



After sunset, as the outdoor air becomes cool, the dried laundry will absorb moisture.

Dehumidifying

The operation mode can be selected accordingly to the situation.

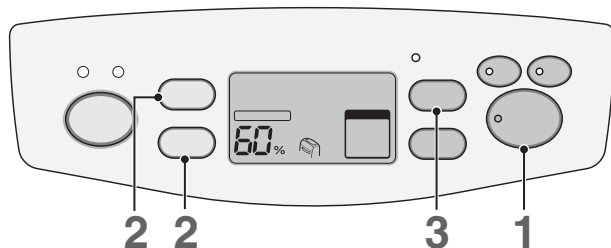

Press  to begin operation.

- POWER lamp lights.
- The operation mode is displayed.
- Louvre opens, and blows air.

2 Select the operation mode.

<To select the dehumidifying mode and operate>

Press  P13-14

- The operation mode switches each time the button is pressed.

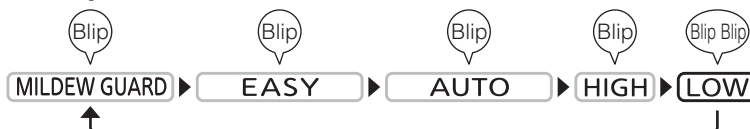

<To set the humidity and operate>

Press  P13

- The set humidity changes each time the button is pressed.

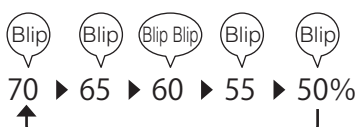

3 Press and select the swing direction. P16

<To stop operation>

Press  

- POWER lamp goes out.
- The operation mode indicator goes out.

Information

- When operating in the EASY, AUTO, HIGH, or LOW mode, the unit will automatically stop after 12 hours have elapsed since the last operation in order to prevent forgetting to turn the power off. P8
- The dehumidifier remembers the operation mode. Even if the power plug is disconnected or the power is turned off, the unit restarts at the previous setting.
- The humidity cannot be set in modes other than "AUTO".
- Operation stops when the tank is full. To restart operation, remove water from the tank. If a continuous drainage hose is set, the dehumidifier will operate continuously. P20
- In the case of a power outage during operation, the dehumidifier will restart operation upon restoration in the operation mode before the power outage.
- If the DRYING INSIDE (auto) operation has been activated, the DRYING INSIDE operation will start after the unit stops. P18

Note When drying your shoes, put them in a position slightly higher from the floor so that the air from the dehumidifier is directed to them.

EASY

To relieve the discomfort from dampness, the unit operates intermittently after the automatic switching of airflow rate. Blowing air is used to control the room temperature rise if the room temperature is high. It is recommended when you want to maintain the comfortable level of humidity.

- If the set humidity level is reached, sometimes the blower/louvre will stop operating.

Installing the dehumidifier

Place the dehumidifier in the room to use it.
(Make sure the back of the dehumidifier is not too close to any walls)

P5

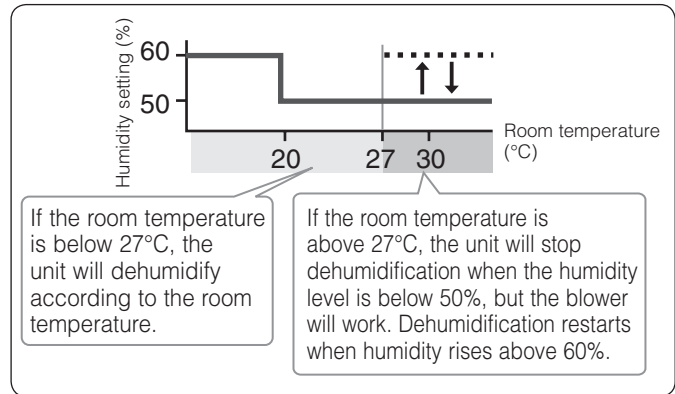
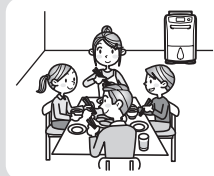

AUTO

In order to maintain the humidity level, the unit operates intermittently after automatic switching of air flow rate.

- When the current humidity is lower than the set value, the unit will stop (both the blower/louvre will stop). It will restart if the humidity level is higher than the set value.
- For 6 minutes after the power is on, the unit will begin operating regardless of the room humidity.

Information

Sometimes it would take a long time to bring down the humidity depending on opening and closing frequency of the room door or the size or shape of the room.

Installing the dehumidifier

Place the dehumidifier in the room to use it.
(Make sure the back of the dehumidifier is not too close to any walls)

P5



<To confirm the humidity setting>

- After displaying **SELECTION**, the current humidity setting is displayed.



Press

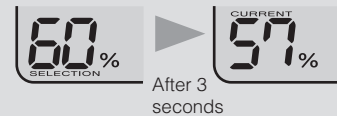

After approximately 3 seconds, the display returns to the current humidity display.

HIGH

The blower operates continuously in HIGH airflow mode.

It is recommended for strong dehumidification.

LOW

The blower operates continuously in LOW airflow mode. It is recommended when you want to dehumidify with lower blower sounds.

Installing the dehumidifier

Place the dehumidifier so that its back faces a closet or wardrobe to use it.



Dehumidifying (Cont.)

MILDEW GUARD

In this mode, the unit can dehumidify the bathroom to remove residual moisture and water drops, thus suppressing the mildew growth as a means of mildew prevention.

To install the unit

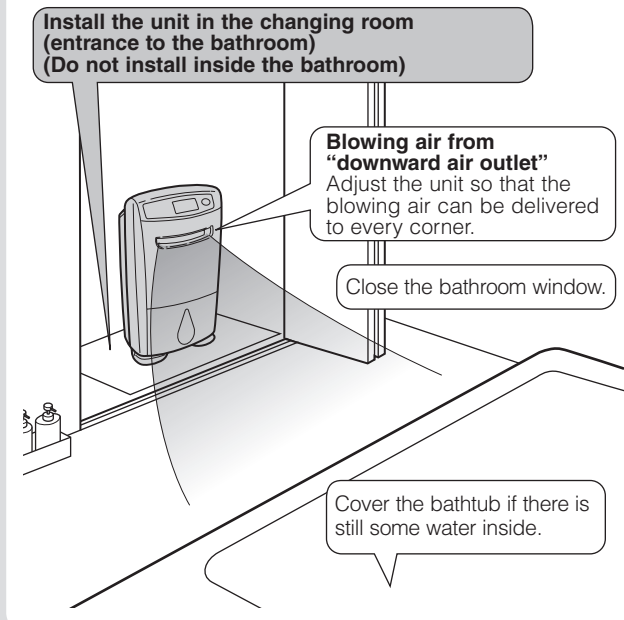

CAUTION



Do not use the unit in a bathroom or other location where it is likely to come into contact with water, or wash it with water.

Exposure to water may result in **fire or electric shock** caused by an electric leak.

Information

- For better results, do not turn on the room ventilation fan or open the window or door when the unit is operating.
- The results may vary depending on the size, floor and wall materials of the bathroom.
- There may be some residual water drops in the places that can collect water.
- Mildew growth may still occur due to the fungus type and conditions of the room.
<e.g.> Under the containers of the bathroom, deeper inside of closets and behind furniture and places with bad air flow.
- Places such as inside of the bathtub, under containers or where the blowing air cannot reach, cannot be dried.
- This mode does not remove existing mildew, scales and sticky liquids around the sinkhole.
- When it is used with the OFF TIMER mode, the unit may stop operating before completing the drying operation.

About MILDEW GUARD mode

The unit continues to operate for about another 4 hours after the humidity decreases to 50% and then stops automatically. The operation time varies depending on temperature and humidity and ranges from approximately 4 hours (approximately 6 hours if the room temperature is below 20°C) to approximately 12 hours.

How is mildew growth suppressed?

Mildew is unable to produce new spores if it is dried as mycelia. This principle is applied to the MILDEW GUARD function. (However, the spores have high resistance to dryness.)

"Research of Black Mold"
Experimental data from General Incorporated
Association Mold Prediction Laboratory

Operating each operation mode

Operation mode	Automatic stop	Continuous operation
EASY	—	△*
AUTO	—	△*
HIGH	—	○
LOW	—	○
MILDEW GUARD	○ (Operates for 4 to 12 hours)	—

Information

- Operation stops when the tank is full. To restart operation, remove water from the tank.
- When operating in the EASY, AUTO, HIGH, or LOW mode, the unit will automatically stop after 12 hours have elapsed since the last operation in order to prevent forgetting to turn the power off. P8

* Operates continuously according to the room temperature and humidity. (Operates while turning the blower and compressor ON and OFF)

Cleaning the Air (AIR PURIFIER)

To operate the air purifier only.

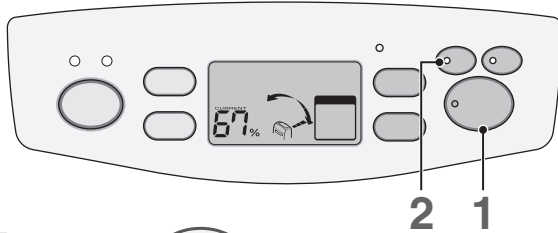

1 Press Blip

2 Press Blip

● **AIR PURIFIER lamp lights.**

To return to the previous mode, press the AIR PURIFIER switch again.

● AIR PURIFIER

The unit cleans the air by passing it through the pre-filter and silver ion filter. The dehumidifier function is disabled.

Information

- The air passes through the silver ion filter in all modes, cleaning the air even if the AIR PURIFIER lamp is not lit.
- Cigarette smoke and toxins found in smoke, such as carbon monoxide, cannot be removed with these filters.

Replacement Parts

The silver ion filter is consumable part. Please replace the filter regularly. Switch the POWER to "OFF", unplug the power plug, and check that the blower fan has stopped before replacing the filter.

Replacing the silver ion filter

Although the filter life is 2 years, replace it in case of the following.

- The filter has been soaked for 8 times.
- The silver ion filter has turned brown or black due to cigarette smoke or dust.

Filter life differs depending on usage and environmental conditions.

Remove the pre-filter from the unit, and replace the silver ion filter.

How to remove and attach the filter P9

Parts sold separately

Silver ion filter for replacement

- Type: MJPR-18WXFT

For these items contact your nearest Mitsubishi Electric dealer.

Using Child Lock

The switches can be locked.

To prevent children from operating this unit, use this function.

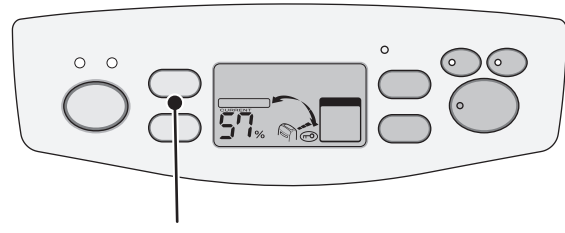

Press for 3 seconds or more.

● The child lock indicator is displayed.

(Example)

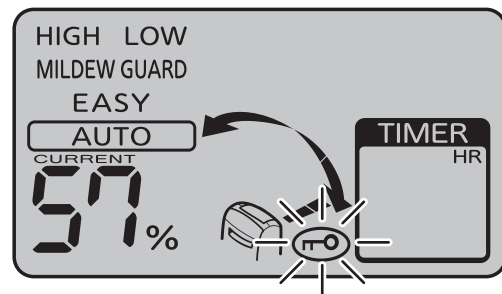

■ If you lock the unit when the **POWER is OFF**.

The unit will not turn on, even if you press the POWER switch to turn it on. The LCD backlight and child lock indicator will blink.

■ If you lock the unit when the **POWER is ON**.

The unit will not turn off, even if you press the POWER switch to turn it off. Only the child lock indicator will blink.

Information

- When the child lock is set, only the CHILD LOCK switch can be used. When the child lock is activated, other switches are not operable. Deactivate the child lock in order to use other switches.
- The child lock is cancelled when the power cord is unplugged.

<Releasing the child lock>

Press for 3 seconds or more.

● The child lock indicator goes out.

(Example)

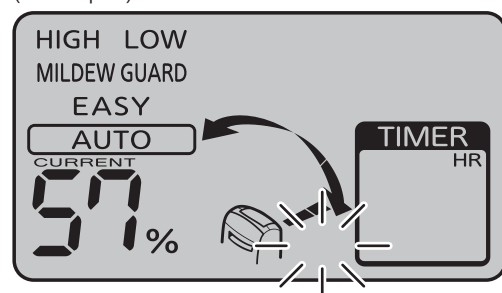

Using Louvre

The louvre can be made to swing. Select from 5 possible settings to suit the purpose.

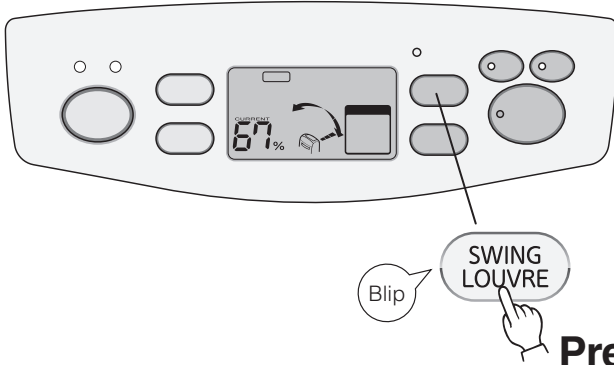

- Automatic louvre starts
- The monitor displays louvre direction

Remove the plug from the power socket and connect again, automatic louvre stops.

Displays louvre swing range
(The louvre and monitor do not move in synchronization.)

Each time the switch is pressed, the swing direction changes.

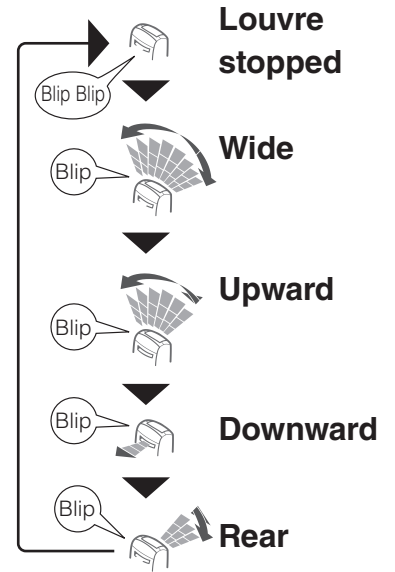

Objective	Recommended swing mode	Explanation of swing
To stop the louvre at the desired angle	<ul style="list-style-type: none"> ● Louvre stopped 	Louvre stops in a vertical position, and louvre display screen will disappear. To change louvre to a desired angle, adjust the louvre angle by hand.
To cover the entire room	<ul style="list-style-type: none"> ● Wide <p>Approximately 120°</p>	The louvre swings from the upward position to the rear position to send air to all corners of the room.
To dry the laundry	<ul style="list-style-type: none"> ● Upward <p>Approximately 90°</p>	The louvre swing speed is automatically controlled so that there is even distribution of air supply to the laundry. <p>The louvre moves slowly through the last 30° of the swing, as it takes shorter time to traverse the upward arc than the rear arc when louvre moves at a constant speed.</p>
To dehumidify carpets and beds To dry training shoes	<ul style="list-style-type: none"> ● Downward 	The louvre does not swing. The angle of louvre can be adjusted manually for downward air blowing. (3-section adjustable louvre) The louvre is adjusted in the air-blowing direction, so do not close the louvre. <p>Adjust the louvre direction by hand.</p>
To dehumidify closets	<ul style="list-style-type: none"> ● Rear <p>Approximately 60°</p>	The louvre swings to send air to the back of the unit. The louvre has a variety of angles, so there may be a small amount of air coming from the downward outlet.

- Information**
- The level of noise emitted from the unit varies depending on the air-blowing direction.
 - To locate the position, the air outlet may stop up to 8 seconds and then start operating again.
 - If the louvre is touched by hand or object, the louvre angle will change, so readjust the louvre by pressing the direction switch.
 - If air is blown directly onto a wall, the wall may become dirty because of dust in the air.
 - This dehumidifier memorizes the swing direction but not the desired angle at which the louvre was stopped. The next time you start it, it returns to the default setting (upward).

Note When drying your shoes, put them in a position slightly higher from the floor so that the air from the dehumidifier is directed to them.

Using Timer

OFF TIMER operation

The OFF TIMER can be set between 1 to 9 hours. Set the timer when the power is switched on.

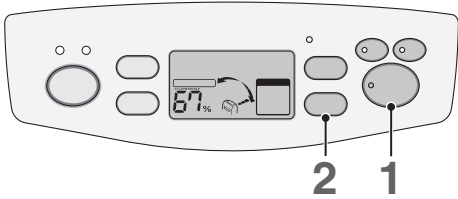

Setting OFF TIMER

1 Switch the power ON.

- Select operation mode. P10-14
- Select the louvre swing direction. P16

2 Set the operation time.



- Press once to display “!” “OFF”.
- Each press will change the display in the sequence of 1 to 9 hours.

(Holding the switch will cause the display to change continuously.)

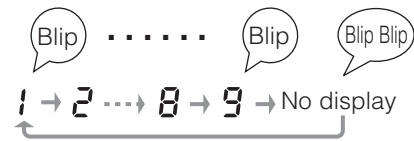

→The OFF TIMER is set.

- The remaining time will decrease one hour after each hour elapses.

- When the set time is reached, the unit stops automatically and the louvre closes automatically.

DRYING INSIDE (auto) operation will start if it has been activated. P18

Cancellation

<When you want to stop operation>

Press POWER switch → OFF

<When you want to disable the OFF TIMER mode and continue operation>

Press and hold the ON/OFF TIMER switch until the remaining time disappears from the display.

Information

- Empty the water tank before operating. During operation, if the tank becomes full, the FULL lamp lights and the unit stops.
- The OFF TIMER and ON TIMER cannot be set at the same time.
- If the OFF TIMER mode is used with the INTELLIGENT LAUNDRY, NIGHT LAUNDRY or MILDEW GUARD, the unit may stop before the laundry or the bathroom is dry.
- The OFF TIMER cannot be set during DRYING INSIDE operation.

ON TIMER operation

The ON TIMER can be set between 1 to 9 hours. Set the timer when the POWER is off.

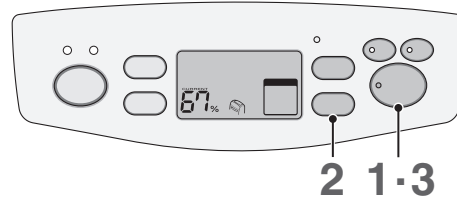

Setting ON TIMER

1 Switch the power OFF.

2 Set the time you wish the unit to turn ON.

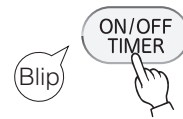

- Press once, the operation mode indicator and “!” on the digital display flash, and “ON” is displayed.
- Each press will change the display in the sequence of 1 to 9 hours.

(Holding the switch will cause the display to change continuously)



- Select operation mode. P10-14

Set the DRYING INSIDE (auto) operation as desired. P18

- Select the louvre swing direction. P16

3 Confirm the time setting by pressing the POWER switch.

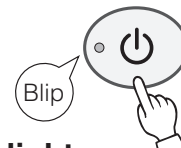

- The timer display lights.
→ The ON TIMER is set.

If both the timer display and operation mode indicator blink, it means the POWER switch is not pressed. (An alarm “blip blip” sounds for 1 minute.)

- The remaining time will decrease one hour after each hour elapses.

- When the set time is reached, the unit automatically starts.

Cancellation

Press POWER switch → OFF

Information

- When the ON TIMER is set during the DRYING INSIDE operation, the operation is stopped.
- The ON TIMER function is not operable using a commercially-available timer plug.

Drying Inside Operation

The inside of the unit can be dried to suppress mildew growth on the cooler.

The DRYING INSIDE operation is recommended after each use of the unit (approx. one hour).

When continuous operation is being performed by continuous drainage (setting hose), there is no need to perform the DRYING INSIDE operation every day. However it is recommend that DRYING INSIDE operation is used after every two weeks.

Automatic Operation

To activate DRYING INSIDE operation after each use

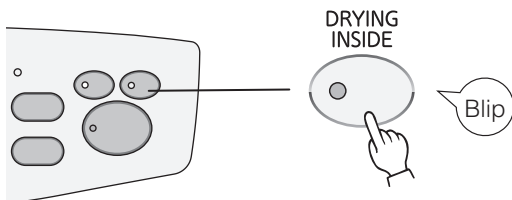

**Press while the
POWER is ON**

- **DRYING INSIDE operation standby**
(DRYING INSIDE lamp lights.)

**DRYING INSIDE operation starts when
dehumidifying ends.**

- **DRYING INSIDE operation starts.**
The DRYING INSIDE lamp flashes, the humidity indicator turns off, and the louvre stops in the vertical position.

DRYING INSIDE Operation

- **DRYING INSIDE operation ends.**
The DRYING INSIDE lamp turns off and the louvre closes.

<To deactivate the automatic operation>

Press the DRYING INSIDE switch when the POWER is ON.
(The DRYING INSIDE lamp turns off.)

Manual Operation

The DRYING INSIDE operation can only start when the POWER is OFF.

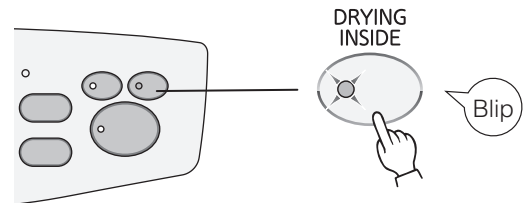

**Press while the
POWER is OFF**

- **DRYING INSIDE operation starts.**
The DRYING INSIDE lamp flashes, the humidity indicator turns off, and the louvre stops in the vertical position.

DRYING INSIDE Operation

- **DRYING INSIDE operation ends.**
The DRYING INSIDE lamp turns off and the louvre closes.

To abort DRYING INSIDE operation

Press the DRYING INSIDE switch while the unit is performing the DRYING INSIDE operation (the DRYING INSIDE lamp turns off).

Press the POWER switch to abort the DRYING INSIDE operation and resume the regular operation.

Information

- Disconnecting the power plug will stop the automatic operation.
- This function does not remove existing mildew. Also, aborting the DRYING INSIDE operation may cause the benefits to diminish.
- During DRYING INSIDE operation, do not close the louvre. It will cause noise.
- The moisture expelled from inside the unit may cause the room humidity level to rise.
- The air emitting from the unit may appear white depending on the humidity or temperature of the room.
- The moisture expelled from inside the unit may have a smell due to odorants, which have not been caught by the filter and dissolve in water.
 - * The silver ion filter is mainly for absorbing ammonia.
- During DRYING INSIDE operation, the OFF TIMER cannot be set.
- If operation is stopped while the FULL lamp is lit, the DRYING INSIDE operation cannot be set unless the power is turned off.

Draining

When the tank is full (approximately 4.7 L), the unit automatically stops and the FULL lamp lights. Please empty the tank.

When the water tank becomes full, the FULL lamp lights.

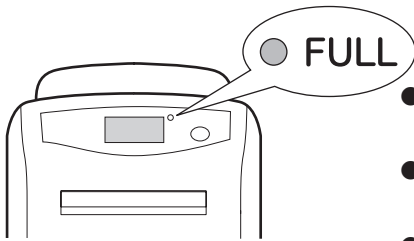

- **FULL lamp lights.**
(There will be continuous sounds "bleep bleep bleep".)
- **Airflow stops.**
(Louvre stops.)
- **LCD indicators go out.**

Information

- After pouring out the water, replace the water tank, and the FULL lamp will go out. The unit restarts. If 12 hours elapse since operation was restarted, the auto power-off function will cause the unit to stop automatically.
 - When the FULL lamp is on, other operations are forbidden except for pressing the POWER switch.
 - In OFF TIMER operation, the FULL lamp is ON as indicator.
- <In NIGHT LAUNDRY mode>**
- When the water tank becomes full, the unit stops dehumidification but the air supply continues. Though the FULL lamp lights, there will be no warning sound. The air supply continues even if the water tank has been removed.

1 Remove the water tank.

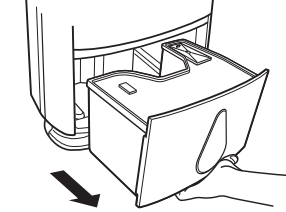

Place your hand on the handle and carefully pull the water tank out straight to prevent water from spilling.

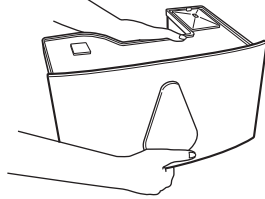

Hold the water tank.

2 Remove the tank lid, and pour out the water.

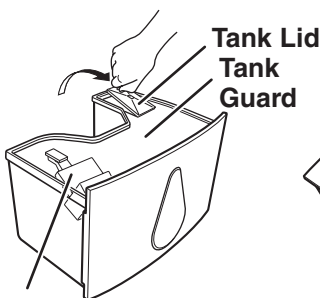

Tank Lid
Tank Guard

Floating Element
Do not remove or dismantle the floating element.

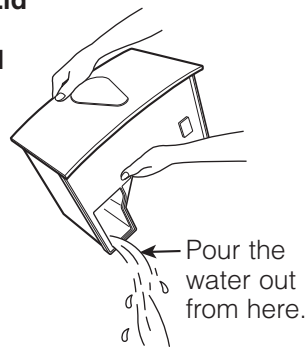

Pour the water out from here.

3 Slide the tank lid to close the tank.

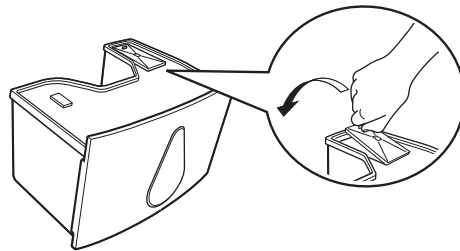

4 Check the tank, and firmly push it all the way in.

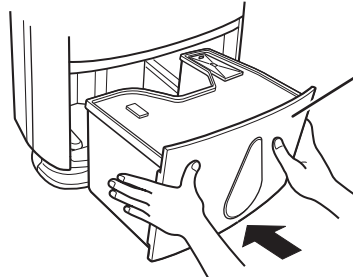

Tank
Make sure the tank is not broken or cracked.

Confirm that the tank lid and the tank guard are securely attached, and push the tank in with both hands.
(Sounds "Blip".)

Information

If the tank is not installed correctly, the FULL lamp will come on, and the unit will not operate.

Note

- Secure the tank lid and tank guard properly or else the tank may become stuck.
- Do not remove or dismantle the floating element from the tank. If it is removed, the unit cannot detect the water level, and this could result in leakage.

Continuous Drainage

If a drain is available, the unit can continuously drain water by attaching a commercially available hose (with an internal diameter of 15 mm) to the drain. As the unit does not stop due to the water tank being full, it can be operated for a long period of time without the need to empty the water tank. If there is power outage during operation, once power is restored, the unit resumes in the mode it was operating before power outage.

If you want to operate the unit for 12 hours or more, turn OFF the auto power-off function.

When operating in the EASY, AUTO, HIGH, or LOW mode, the unit will automatically stop after 12 hours have elapsed since the last operation in order to prevent forgetting to turn the power off.

Use with the auto power-off function turned OFF. P8

Items to prepare

- **Commercially available hose (ID 15 mm)**
Long enough to reach the drain.
- **Pincers**



CAUTION



Do not drain water continuously if there is a possibility that temperature around the hose could drop to freezing point.

Water inside the hose may freeze and prevent the water in the tank from flowing out. The water may leak from the unit and **damage surrounding objects.**



When draining water continuously or left unattended for long periods, inspect the unit every two weeks.

When the filter or hose is clogged with foreign materials or dirt, **the dehumidification operation is disabled and may cause leakage.**

Turn off the power switch and unplug the power cord.

1 Remove the water tank.

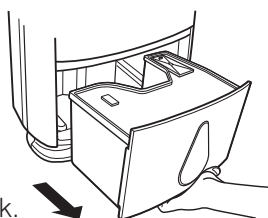

Remove the water tank.

2 Open the drainage outlet.

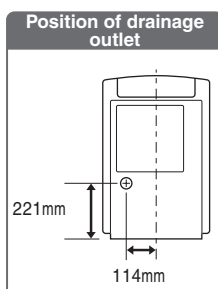
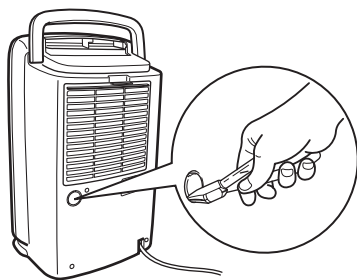

Use pincers to cut the three fixing ribs, taking care not to let them fall into the unit.

3 Insert the hose into the drainage outlet.

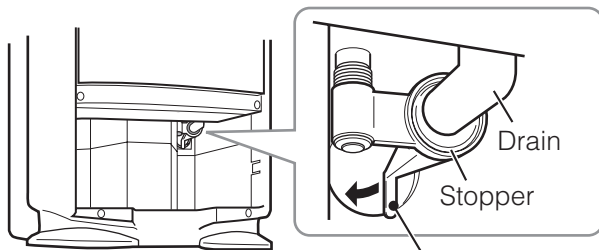

Push here.

4 Insert hose onto the drainage outlet from the back.

① Attach the commercially available hose (ID 15 mm) to the continuous drainage outlet of the unit.

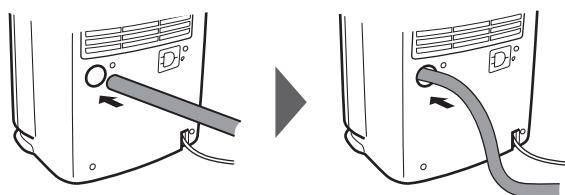

② Confirm that the hose is securely attached and does not leak.

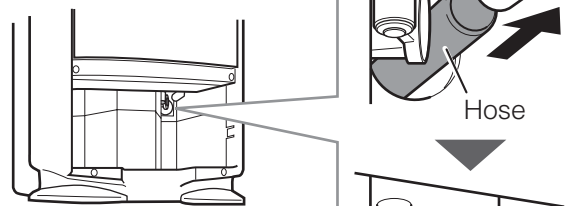

③ Confirm that the hose does not show signs of deterioration such as cracks or bends.

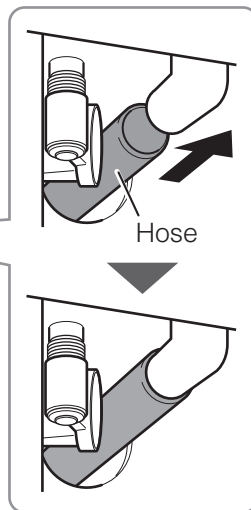

5 Attach the tank, and set the end of the hose into the drain.

If the tank is not reattached, the FULL lamp remains on and operation is not possible.

Drainage Hose Installation Example

Correct

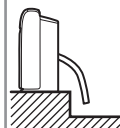

Incorrect



Hose is immersed in water.



Hose is going over a step.



Hose is higher than the drainage outlet.

- Water will not be drained.
- Water will be collected in the water tank. When the tank becomes full, the unit operation will stop.

Note

- Make sure the hose is in good condition free of bends and cracks.
- If it is hard to insert the hose, put it in water and then insert it. Do not use oils or lubricants.
- Inspect the hose once every 2 weeks. (Insects or dirt deposits in the hose may cause leakage.)

Maintenance

Do not use detergents, cleaning agents for heat exchange equipment, decontaminative powders, chemically treated cloth, gasoline, volatile oil, thinners, etc. They can damage the water tank or main body, which may result in leakage. Before maintenance, set the POWER switch to "OFF" and unplug the power plug.

When Cleaning the Unit

Water tank • Main body

Wipe with a soft cloth.

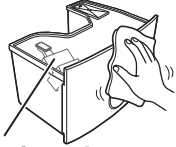

Floating element

Do not remove or dismantle.



- Because the dust in the air may cause the tank lid and water tank to become dirty. If the dirt cannot be removed, wash with water then wipe with a dry cloth.
- Mildew may form in the water tank when the dirt is not removed thoroughly.

Once Every Two Weeks

Pre-filter

Use a vacuum cleaner to suck up dirt.

Clogged pre-filter will reduce the effectiveness of dehumidifying and cleaning every two weeks is desirable.

How to remove and attach the filter **P9**

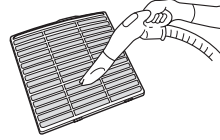

When the pre-filter is very dirty, wash it with warm water or clean water and dry it well.

Once Every Three Months

Silver ion filter

Soak the silver ion filter in water.

How to remove and attach the filter **P9**

- 1 Remove the pre-filter.
- 2 Remove the silver ion filter.
- 3 Soak the silver ion filter in water.

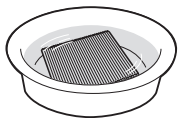

Soak in cool or warm water for about 30 minutes.

Do not use detergent or hot water. Also, do not use a brush or similar tool to scrub the filter or rub the filter while soaking. This may damage the filter.

- There may be yellow or dark stains remain on the filter, but they will not affect the performance.
- The filter can be soaked for a total of eight times. After that, replace it with a new one.

- 4 Dry the silver ion filter well.

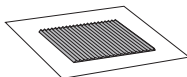

Dry the filter on a flat surface.

Do not hang the filter with pegs or the like. This may damage the filter. Do not use the filter when it is wet.

- 5 Set the silver ion filter.

Make sure the silver ion filter is attached to the unit. If it is not, fine dust will enter into the unit and cause malfunctions.

- 6 Set the pre-filter.

Storage

After switching the unit POWER off, leave for one day until any residual water inside is removed. Then carry out the following steps.

- 1 Perform the DRYING INSIDE operation. **P18**
DRYING INSIDE operation is recommended for prevention of mildew growth inside the unit.
- 2 Hang the power cord on the cord hook.
- 3 Drain out the water. **P19**
Drain any water from the water tank and wipe off any remaining water.
- 4 Clean the pre-filter.
Use a vacuum cleaner to suck up dirt.
- 5 Store the unit.
 - Dry the unit fully and wipe off any dust with cloth.
 - Store the unit in a place not exposed to direct sunlight and keep it in upright position.

Troubleshooting

● For the symptoms listed below, refer to the remedies listed right.

Symptom	Cause/Remedy
The unit blows warm air.	<ul style="list-style-type: none"> ● The unit blows out warm air because dehumidified air passes through the re-heater. (There is no cooler function.) This is not a malfunction. P6
Water does not collect in the water tank (minimal dehumidifying results).	<ul style="list-style-type: none"> ● Check to see if the temperature/humidity is low. At first, confirm the current humidity. Low humidity reduces dehumidifying effectiveness. (In winter, the dry air makes the humidity low, and the amount of water collected is decreased.) This is not a malfunction. P6
<p>The unit does not operate (no air comes out and the louvre does not swing).</p> <p>The unit stops.</p>	<ul style="list-style-type: none"> ● Check to see whether the power cord is off. → Plug the power cord fully into the power socket. P9
	<ul style="list-style-type: none"> ● Check to see if anything is blocking the air intake or outlet. → Remove the obstruction. P4
	<ul style="list-style-type: none"> ● Check to see if the operation is performed in EASY or AUTO mode. → The unit automatically switches from dehumidification to air blowing and stops. P12-13
	<ul style="list-style-type: none"> ● Check to see if operation is being performed in the MILDEW GUARD mode. → This operation ends automatically when the humidity drops and will stop in 4 hours as minimum. P12-14
	<ul style="list-style-type: none"> ● Check to see if the pre-filter is clogged. → Clean according to the "Maintenance" procedures. P21
	<ul style="list-style-type: none"> ● When operating in the EASY, AUTO, HIGH, or LOW mode, the unit will automatically stop after 12 hours have elapsed since the last operation in order to prevent forgetting to turn the power off. P8
Stops after a short time.	<ul style="list-style-type: none"> ● Check to see if operation is being performed in the INTELLIGENT LAUNDRY or NIGHT LAUNDRY mode. → If the room temperature drops to approximately 5°C or below, the operation will stop in approximately one hour. The reason for this is that if the room temperature is too low, it becomes difficult to remove moisture from the laundry and humidity does not change. P10
○ FULL lights.	<ul style="list-style-type: none"> ● Check to see whether water tank is full. → Empty the water tank and return the water tank to its original position. P19 ● Check to see if the water tank is inserted properly. → Adjust the position of the water tank. P9
The unit continues to operate even though it is turned OFF.	<ul style="list-style-type: none"> ● Check to see if the unit is in DRYING INSIDE operation. The unit starts DRYING INSIDE operation automatically after ending normal operations. P18
The humidity level does not drop to the set level easily.	<ul style="list-style-type: none"> ● Check to see if the room is too large. → Use the unit for the specified area range. ● Check to see if the windows and doors are opened too often. → Try to keep the room closed during operation. ● Check to see if steam producing appliances such as kerosene heaters are on in the vicinity.
The hygrometer reading on the unit differs from other hygrometers in the room.	<ul style="list-style-type: none"> ● Hygrometer readings differ from place to place even if in the same room. Use the unit humidity reading as an estimate. P6
The louvre does not work as set.	<ul style="list-style-type: none"> ● Press the SWING LOUVRE switch again. P16
The louvre remains open when it stops.	<ul style="list-style-type: none"> ● When the power lamp is ON, it operates intermittently. ● When the operation ends, the louvre closes.
The water tank contains liquid or white water residue.	<ul style="list-style-type: none"> ● The residue is from final product testing at the factory and is not a malfunction.
There is black residue on the inside of the water tank and lid.	<ul style="list-style-type: none"> ● The residue is from the dirt in the air. → Clean according to the "Maintenance" procedures. P21

Symptom		Cause/Remedy
The unit makes noises.	The operating noise is loud/reverberates.	<ul style="list-style-type: none"> ● Check to see if the unit is on a slope or uneven surface which causes the unit to tilt or wobble. → Move to a safe and even surface. P4 ● Check to see if the pre-filter is clogged. → Clean according to the methods specified in the "Maintenance" section. P21 ● Operating the unit on a wood board or in a small room is likely to cause acoustic resonance. → Placing a soft mat underneath the unit can reduce the acoustic resonance. P5
	The operating sound suddenly increases in volume.	<ul style="list-style-type: none"> ● Sound increases when the compressor starts operation. (Approximately three minutes after turning on the unit, or during INTELLIGENT LAUNDRY and AUTO operation.)
	The air blowing sound changes in volume.	<ul style="list-style-type: none"> ● The volume of the sound differs depending on the louvre angle. P16
	The unit produces a simmering sound.	<ul style="list-style-type: none"> ● This is the sound of the refrigerant flow. The sound can be heard when the unit is turned on, operation mode is changed or operation stops. No sound can be heard when the refrigerant flow stabilizes.
	The unit produces a buzz that sounds intermittently (or the compressor does not activate).	<ul style="list-style-type: none"> ● This is the sound of the compressor when it starts up. In EASY and AUTO mode, the compressor operates intermittently, so there is compressor startup sound. The compressor does not start when the operation ends or until 3 minutes has passed after the unit is turned on. This is to protect the compressor from damage.
The unit produces an odor.	When first used	<ul style="list-style-type: none"> ● The temperature of heat exchanger goes up rapidly, causing transient odor.
	During DRYING INSIDE operation	<ul style="list-style-type: none"> ● The discharged moisture may emit an odor. It is common that the silver ion filter cannot eliminate all the odors and the odors can be absorbed by moisture inside the unit.
The power plug or power socket generates abnormal heat.		<ul style="list-style-type: none"> ● Stop operation and seek service assistance using the number on the next page.

● **Error message (Humidity indicator)**

Digital Display	Cause/Remedy
A2 or A3 appears.	<ul style="list-style-type: none"> ● Check to see if the power cord is plugged properly. → Correctly plug the power cord into the power socket. P9
P4 appears.	<ul style="list-style-type: none"> ● Check to see if anything is blocking the air outlet. → Remove the obstruction and plug the power cord into the power socket again. P4-9 ● Check to see if the pre-filter is clogged. → Clean according to the "Maintenance" procedures. P21
A1, A6, or E0-E8 appears.	<ul style="list-style-type: none"> ● Malfunction → Take note of error message, unplug the power cord, and seek service assistance using the number on the next page.

- If the symptoms persist even after following the prescribed remedies, or the error message does not disappear, unplug the power cord, and seek service assistance using the number on the next page.
- When unplugging and plugging back the power cord into the power socket, wait at least one minute before plugging it in.

Specifications

Model	MJ-E23AX-A
Power supply	Single phase 230-240 V 50 Hz
Dehumidifying capacity*1	23 L/day
Power consumption	300 W
Water tank capacity	Stops automatically at approx. 4.7 L
Weight	14.4 kg
Dimensions (H x W x D)	594 mm x 372 mm x 281 mm

- The dehumidifying capacity is a value obtained when the dehumidifier is continuously run at a room temperature of 30°C and relative humidity of 80%. It indicates the amount of dehumidification per day (24 hours).

Disposal

Dispose according to the garbage regulations in your district.

- Silver ion filter
Material: PET and PS
- Unit
Do not disassemble. Dispose according to the garbage regulations in your district.

SOLE AGENT in Australia

MITSUBISHI ELECTRIC AUSTRALIA PTY LTD.

(Incorporated in New South Wales) ABN 58 001 215 792
348 Victoria Road, Rydalmere NSW 2116

For more information and support contact

Website: www.mitsubishielectric.com.au

Call 1300 651 808

SOLE AGENT in New Zealand

BLACK DIAMOND TECHNOLOGIES LIMITED (BDT)

Website: <https://www.mitsubishi-electric.co.nz>

Wellington Office (Head Office)

1 Parliament Street, Lower Hutt, PO Box 30772, Lower Hutt 5040 Phone: (04) 560 9147, Fax: (04) 560 9133

Auckland Office

Unit 1, 4 Walls Road, Penrose, PO Box 12726, Penrose, Auckland 1642 Phone: (09) 526 9347, Fax: (09) 526 9348

Christchurch Office

44 Halwyn Drive, Hornby, PO Box 16904, Hornby, Christchurch 8441 Phone: (03) 341 2837, Fax: (03) 341 2838

For after sales and service

Phone: 0800 737 842, Fax: 0800 845 632

Please complete the following form for your future reference.

Place of purchase:	Telephone number:		
Authorised Service Centre:	Telephone number:		
Date of purchase:	Day	Month	Year

MITSUBISHI ELECTRIC CORPORATION

Website: <https://www.mitsubishielectric.com>