

## SPLIT-TYPE AIR CONDITIONERS

### **INDOOR UNIT**

**MSZ-LN25VG2V MSZ-LN35VG2V MSZ-LN50VG3V MSZ-LN60VG3V**  
**MSZ-LN25VG2R MSZ-LN35VG2R MSZ-LN50VG3R MSZ-LN60VG3R**  
**MSZ-LN25VG2B MSZ-LN35VG2B MSZ-LN50VG3B MSZ-LN60VG3B**



### **OPERATING INSTRUCTIONS**

For user

- To use this unit correctly and safely, be sure to read these operating instructions before use.

**English**

# Contents

■ Safety Precautions	1
■ Name of Each Part	4
■ Preparation Before Operation	5
■ I-SEE Operation	6
■ Selecting Operation Modes	7
■ Fan Speed and Airflow Direction Adjustment	8
■ Airflow Control Mode	9
■ Absence Detection	9
■ I-SAVE Operation	10
■ ECONO COOL Operation	10
■ NIGHT MODE Operation	11
■ Air Purifying Operation	11
■ Powerful Operation	12
■ Timer Operation (On/Off Timer)	12
■ Weekly Timer Operation	13
■ Cleaning	14
■ Wi-Fi Interface Setting Up	15
■ When You Think That Trouble has Occurred	18
■ Emergency Operation	20
■ Auto Restart Function	20
■ When the Air Conditioner is not Going to be Used for a Long Time	20
■ Installation Place and Electrical Work	21
■ Specifications	21

# Safety Precautions

## Meanings of symbols displayed on indoor unit and/or outdoor unit

	<b>WARNING</b> (Risk of fire)	This unit uses a flammable refrigerant. If refrigerant leaks and comes in contact with fire or heating part, it will create harmful gas and there is risk of fire.
	Read the OPERATING INSTRUCTIONS carefully before operation.	
	Service personnel are required to carefully read the OPERATING INSTRUCTIONS and INSTALLATION MANUAL before operation.	
	Further information is available in the OPERATING INSTRUCTIONS, INSTALLATION MANUAL, and the like.	

- Since rotating parts and parts which could cause an electric shock are used in this product, be sure to read these "Safety Precautions" before use.
- Since the cautionary items shown here are important for safety, be sure to observe them.
- After reading this manual, keep it together with the installation manual in a handy place for easy reference.
- Be sure to receive a guarantee card from your dealer and check that the purchased data and shop name, etc. are entered correctly.

### Marks and Their Meanings

- WARNING** : Incorrect handling could cause serious hazard, such as death, serious injury, etc. with a high probability.
- CAUTION** : Incorrect handling could cause serious hazard depending on the conditions.

### Meanings of Symbols Used in This Manual

- : Be sure not to do.
- : Be sure to follow the instruction.
- : Never insert your finger or stick, etc.
- : Never step onto the indoor/outdoor unit and do not put anything on them.
- : Danger of electric shock. Be careful.
- : Be sure to disconnect the power supply plug from the power outlet.
- : Be sure to shut off the power.
- : Risk of fire.
- : Never touch with wet hand.
- : Never splash water on the unit.

<b>Warning</b>	
	<p><b>Do not connect the power cord to an intermediate point, use an extension cord, or connect multiple devices to a single AC outlet.</b></p> <ul style="list-style-type: none"> <li>• This may cause overheating, fire, or electric shock.</li> </ul> <p><b>Make sure the power plug is free of dirt and insert it securely into the outlet.</b></p> <ul style="list-style-type: none"> <li>• A dirty plug may cause fire or electric shock.</li> </ul> <p><b>Do not bundle, pull, damage, or modify the power cord, and do not apply heat or place heavy objects on it.</b></p> <ul style="list-style-type: none"> <li>• This may cause fire or electric shock.</li> </ul>

	<p><b>Do not turn the breaker OFF/ON or disconnect/connect the power plug during operation.</b></p> <ul style="list-style-type: none"> <li>• This may create sparks, which can cause fire.</li> <li>• After the indoor unit is switched OFF with the remote controller, make sure to turn the breaker OFF or disconnect the power plug.</li> </ul> <p><b>Do not expose your body directly to cool air for a prolonged length of time.</b></p> <ul style="list-style-type: none"> <li>• This could be detrimental to your health.</li> </ul>
--	---

# Safety Precautions





	<p><b>The unit should not be installed, relocated, disassembled, altered, or repaired by the user.</b></p> <ul style="list-style-type: none"> <li>An improperly handled air conditioner may cause fire, electric shock, injury, or water leakage, etc. Consult your dealer.</li> <li>If the power supply cord is damaged, it must be replaced by the manufacturer or its service agent in order to avoid a hazard.</li> </ul> <p><b>When installing, relocating, or servicing the unit, make sure that no substance other than the specified refrigerant (R32) enters the refrigerant circuit.</b></p> <ul style="list-style-type: none"> <li>Any presence of foreign substance such as air can cause abnormal pressure rise and may result in explosion or injury.</li> <li>The use of any refrigerant other than that specified for the system will cause mechanical failure, system malfunction, or unit breakdown. In the worst case, this could lead to a serious impediment to securing product safety.</li> </ul> <p><b>This appliance is not intended for use by persons (including children) with reduced physical, sensory or mental capabilities, or lack of experience and knowledge, unless they have been given supervision or instruction concerning use of the appliance by a person responsible for their safety.</b></p> <p><b>Children should be supervised to ensure that they do not play with the appliance.</b></p>
	<p><b>Do not insert your finger, a stick, or other objects into the air inlet or outlet.</b></p> <ul style="list-style-type: none"> <li>This may cause injury, since the fan inside rotates at high speeds during operation.</li> </ul>
	<p><b>In case of an abnormal condition (such as a burning smell), stop the air conditioner and disconnect the power plug or turn the breaker OFF.</b></p> <ul style="list-style-type: none"> <li>A continued operation in the abnormal state may cause a malfunction, fire, or electric shock. In this case, consult your dealer.</li> </ul>
	<p><b>When the air conditioner does not cool or heat, there is a possibility of refrigerant leakage. If any refrigerant leakage is found, stop operations and ventilate the room well and consult your dealer immediately. If a repair involves recharging the unit with refrigerant, ask the service technician for details.</b></p> <ul style="list-style-type: none"> <li>The refrigerant used in the air conditioner is not harmful. Normally, it does not leak. However, if refrigerant leaks and comes in contact with fire or heating part of such a fan heater, kerosene heater, or cooking stove, it will create harmful gas and there is risk of fire.</li> </ul> <p><b>The user should never attempt to wash the inside of the indoor unit. Should the inside of the unit require cleaning, contact your dealer.</b></p> <ul style="list-style-type: none"> <li>Unsuitable detergent may cause damage to plastic material inside the unit, which may result in water leakage. Should detergent come in contact with electrical parts or the motor, it will result in a malfunction, smoke, or fire.</li> <li>The appliance shall be stored in a room without continuously operating ignition sources (for example: open flames, an operating gas appliance or an operating electric heater).</li> <li>Be aware that refrigerants may not contain an odour.</li> <li>Do not use means to accelerate the defrosting process or to clean the appliance, other than those recommended by the manufacturer.</li> <li>Do not pierce or burn.</li> </ul> <p><b>The indoor unit must be installed in rooms which exceed the floor space specified. Please consult your dealer.</b></p> <p><b>When the indoor unit is connected to the multi type outdoor unit of R32 refrigerant, please consult your dealer about the floor space specified.</b></p>
	<p><b>This appliance is intended to be used by expert or trained users in shops, in light industry and on farms, or for commercial use by lay persons.</b></p> <p><b>Do not touch the air purifying device from the top of the indoor unit during operation.</b></p>
<b>Caution</b>	
	<p><b>Do not touch the air inlet or the aluminum fins of the indoor/outdoor unit.</b></p> <ul style="list-style-type: none"> <li>This may cause injury.</li> </ul> <p><b>Do not use insecticides, flammable sprays, air refreshers, or antibacterial agents on the unit.</b></p> <ul style="list-style-type: none"> <li>This may cause a fire or deformation of the unit.</li> </ul> <p><b>Do not expose pets or houseplants to direct airflow.</b></p> <ul style="list-style-type: none"> <li>This may cause injury to the pets or plants.</li> </ul> <p><b>Do not place other electric appliances or furniture under the indoor/outdoor unit.</b></p> <ul style="list-style-type: none"> <li>Water may drip down from the unit, which may cause damage or malfunction.</li> </ul> <p><b>Do not leave the unit on a damaged installation stand.</b></p> <ul style="list-style-type: none"> <li>The unit may fall and cause injury.</li> </ul> <p><b>Do not step on an unstable bench to operate or clean the unit.</b></p> <ul style="list-style-type: none"> <li>This may cause injury if you fall down.</li> </ul>

	<p><b>Do not pull the power cord.</b></p> <ul style="list-style-type: none"> <li>This may cause a portion of the core wire to break, which may cause overheating or fire.</li> </ul> <p><b>Do not charge or disassemble the batteries, and do not throw them into a fire.</b></p> <ul style="list-style-type: none"> <li>This may cause the batteries to leak, or cause a fire or explosion.</li> </ul> <p><b>Do not operate the unit for more than 4 hours at high humidity (80% RH or more) and/or with windows or outside door left open.</b></p> <ul style="list-style-type: none"> <li>This may cause the water condensation in the air conditioner, which may drip down, wetting or damaging the furniture.</li> <li>The water condensation in the air conditioner may contribute to growth of fungi, such as mold.</li> </ul> <p><b>Do not use the unit for special purposes, such as storing food, raising animals, growing plants, or preserving precision devices or art objects.</b></p> <ul style="list-style-type: none"> <li>This may cause deterioration of quality, or harm to animals and plants.</li> </ul> <p><b>Do not expose combustion appliances to direct airflow.</b></p> <ul style="list-style-type: none"> <li>This may cause incomplete combustion.</li> </ul> <p><b>Never put batteries in your mouth for any reason to avoid accidental ingestion.</b></p> <ul style="list-style-type: none"> <li>Battery ingestion may cause choking and/or poisoning.</li> </ul>
	<p><b>Before cleaning the unit, switch it OFF and disconnect the power plug or turn the breaker OFF.</b></p> <ul style="list-style-type: none"> <li>This may cause injury, since the fan inside rotates at high speeds during operation.</li> </ul> <p><b>When the unit will be unused for a long time, disconnect the power plug or turn the breaker OFF.</b></p> <ul style="list-style-type: none"> <li>The unit may accumulate dirt, which may cause overheating or fire.</li> </ul> <p><b>Replace all batteries of the remote controller with new ones of the same type.</b></p> <ul style="list-style-type: none"> <li>Using an old battery together with a new one may cause overheating, leakage, or explosion.</li> </ul> <p><b>If the battery fluid comes in contact with your skin or clothes, wash them thoroughly with clean water.</b></p> <ul style="list-style-type: none"> <li>If the battery fluid comes in contact with your eyes, wash them thoroughly with clean water and immediately seek medical attention.</li> </ul> <p><b>Ensure that the area is well-ventilated when the unit is operated together with a combustion appliance.</b></p> <ul style="list-style-type: none"> <li>Inadequate ventilation may cause oxygen starvation.</li> </ul> <p><b>Do not operate the air conditioner after applying protecting agent on the floor.</b></p> <ul style="list-style-type: none"> <li>Components in the protecting agent may attach the inside of the indoor unit, resulting in water leakage or splattering of dew.</li> </ul> <p><b>Turn the breaker OFF when you hear thunder and there is a possibility of a lightning strike.</b></p> <ul style="list-style-type: none"> <li>The unit may be damaged if lightning strikes.</li> </ul> <p><b>After the air conditioner is used for several seasons, perform inspection and maintenance in addition to normal cleaning.</b></p> <ul style="list-style-type: none"> <li>Dirt or dust in the unit may create an unpleasant odor, contribute to growth of fungi, such as mold, or clog the drain passage, and cause water to leak from the indoor unit. Consult your dealer for inspection and maintenance, which require specialized knowledge and skills.</li> </ul>
	<p><b>Do not operate switches with wet hands.</b></p> <ul style="list-style-type: none"> <li>This may cause electric shock.</li> </ul> <p><b>Do not clean the air conditioner with water or place an object that contains water, such as a flower vase, on it.</b></p> <ul style="list-style-type: none"> <li>This may cause fire or electric shock.</li> </ul>
	<p><b>Do not step on or place any object on the outdoor unit.</b></p> <ul style="list-style-type: none"> <li>This may cause injury if you or the object falls down.</li> </ul>







<b>Important</b>	
<p><b>Dirty filters cause condensation in the air conditioner which will contribute to the growth of fungi such as mold. It is therefore recommended to clean air filters every 2 weeks.</b></p> <p><b>Before starting the operation, ensure that the horizontal vanes are in the closed position. If operation starts when the horizontal vanes are in the open position, they may not return to the correct position.</b></p>	

# Safety Precautions

## For Installation

 <b>Warning</b>	
	<p><b>Consult your dealer for installing the air conditioner.</b></p> <ul style="list-style-type: none"> <li>It should not be installed by the user since installation requires specialized knowledge and skills. An improperly installed air conditioner may cause water leakage, fire, or electric shock.</li> </ul>
	<p><b>Provide a dedicated power supply for the air conditioner.</b></p> <ul style="list-style-type: none"> <li>A non-dedicated power supply may cause overheating or fire.</li> </ul>
	<p><b>Do not install the unit where flammable gas could leak.</b></p> <ul style="list-style-type: none"> <li>If gas leaks and accumulates around the outdoor unit, it may cause an explosion.</li> </ul>
	<p><b>Earth the unit correctly.</b></p> <ul style="list-style-type: none"> <li>Do not connect the earth wire to a gas pipe, water pipe, lightning rod, or a telephone earth wire. Improper earthing may cause electric shock.</li> </ul>
 <b>Caution</b>	
	<p><b>Install an earth leakage breaker depending on the installation location of the air conditioner (such as highly humid areas).</b></p> <ul style="list-style-type: none"> <li>If an earth leakage breaker is not installed, it may cause electric shock.</li> </ul>
	<p><b>Ensure that the drain water is properly drained.</b></p> <ul style="list-style-type: none"> <li>If the drain passage is improper, water may drip down from the indoor/outdoor unit, wetting and damaging the furniture.</li> </ul>
<p><b>In case of an abnormal condition</b> Immediately stop operating the air conditioner and consult your dealer.</p>	

## For Wi-Fi Interface

 <b>Warning</b>	
(Improper handling may have serious consequences, including serious injury or death.)	
	<p><b>This appliance can be used by children aged from 8 years and above and persons with reduced physical, sensory or mental capabilities or lack of experience and knowledge if they have been given supervision or instruction concerning use of the appliance in a safe way and understand the hazards involved.</b></p> <p><b>Children shall not play with the appliance. Cleaning and user maintenance shall not be made by children without supervision.</b></p> <p><b>Do not use the Wi-Fi interface nearby the medical electrical equipment or people who have a medical device such as a cardiac pacemaker or an implantable cardioverter-defibrillator.</b></p> <ul style="list-style-type: none"> <li>It can cause an accident due to malfunctions of the medical equipment or device.</li> </ul> <p><b>Do not install the Wi-Fi interface nearby the automatic control devices such as automatic doors or fire alarms.</b></p> <ul style="list-style-type: none"> <li>It can cause accidents due to malfunctions.</li> </ul>
	<p><b>Do not touch the Wi-Fi interface with wet hands.</b></p> <ul style="list-style-type: none"> <li>It can cause damage to the device, electric shock, or fire.</li> </ul>
	<p><b>Do not splash water on the Wi-Fi interface or use it in a bathroom.</b></p> <ul style="list-style-type: none"> <li>It can cause damage to the device, electric shock, or fire.</li> </ul>
	<p><b>When the Wi-Fi interface is dropped, or the holder or cable is damaged, disconnect the power supply plug or turn the breaker OFF.</b></p> <ul style="list-style-type: none"> <li>It may cause fire or electric shock. In this case, consult your dealer.</li> <li>This device complies with all Australia and New Zealand requirements for EMC and electrical safety.</li> </ul>
 <b>Caution</b>	
(Improper handling may have consequences, including injury or damage to building.)	
	<p><b>Do not step on unstable stepstool to set up or clean the Wi-Fi interface.</b></p> <ul style="list-style-type: none"> <li>It may cause injury if you fall down.</li> </ul> <p><b>Do not use the Wi-Fi interface nearby other wireless devices, microwaves, cordless phones, or facsimiles.</b></p> <ul style="list-style-type: none"> <li>It can cause malfunctions.</li> </ul>

# Name of Each Part

## Indoor unit

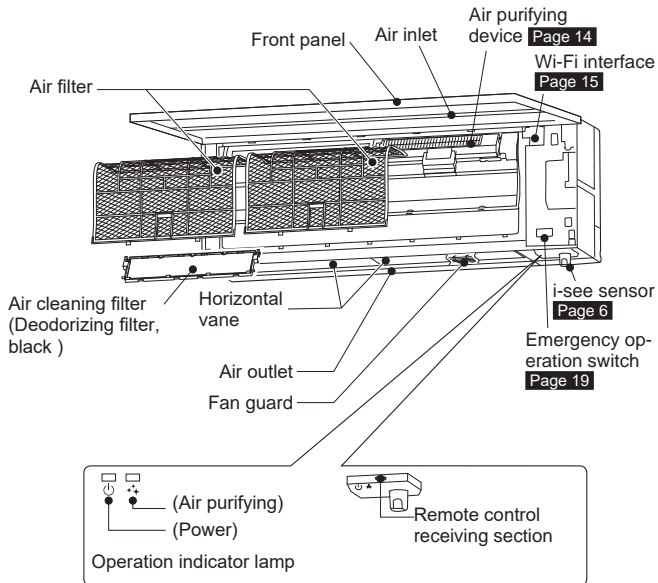

## Outdoor unit

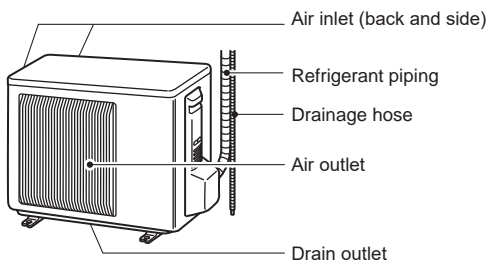

Outdoor units may be different in appearance.

## Remote controller

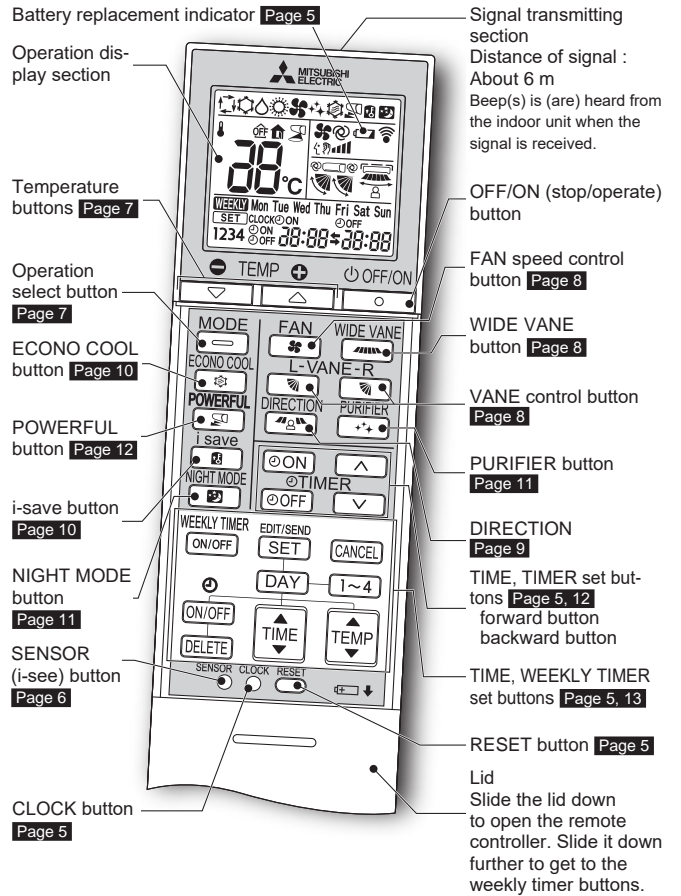

### Remote controller holder

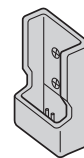

- Install the remote controller holder in a place where the signal can be received by the indoor unit.
- When the remote controller is not used, place it in this holder.

Only use the remote controller provided with the unit.  
Do not use other remote controllers.  
If 2 or more indoor units are installed in proximity to one another, an indoor unit that is not intended to be operated may respond to the remote controller.

# Preparation Before Operation

**Before operation:** Insert the power supply plug into the power outlet and/or turn the breaker on.

## Installing the remote controller batteries

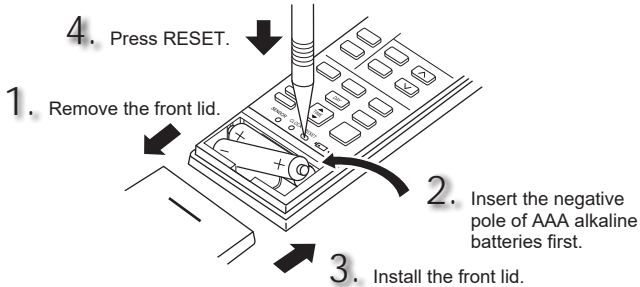

**Note:**

- Make sure the polarity of the batteries is correct.
- Do not use manganese batteries and leaking batteries. The remote controller could malfunction.
- Do not use rechargeable batteries.
- The battery replacement indicator lights up when the battery is running low. In about 7 days after the indicator starts lights up, the remote controller stops working.
- Replace all batteries with new ones of the same type.
- Batteries can be used for approximately 1 year. However, batteries with expired shelf lives last shorter.
- Press RESET gently using a thin instrument.  
If the RESET button is not pressed, the remote controller may not operate correctly.

## Setting current time

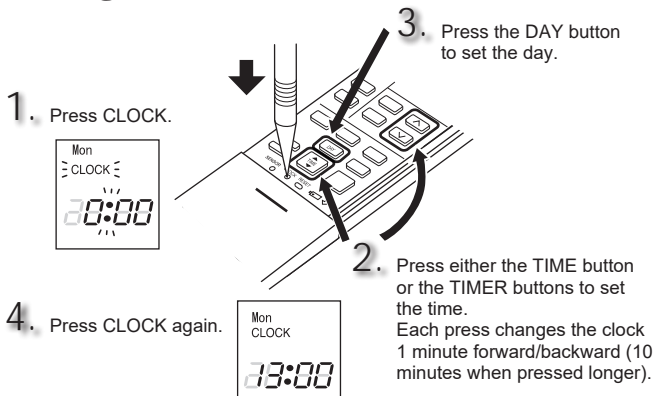

**Note:**

- Press CLOCK gently using a thin instrument.

**Note:**

**How to set remote controller exclusively for a particular indoor unit**

A maximum of 4 indoor units with wireless remote controllers can be used in a room. To operate the indoor units individually with each remote controller, assign a number to each remote controller according to the number of the indoor unit. This setting can be set only when all the following conditions are met:

- The remote controller is powered OFF.
- (1) Hold down [1~4] button on the remote controller for 2 seconds to enter the pairing mode.
- (2) Press [1~4] button again and assign a number to each remote controller. Each press of [1~4] button advances the number in the following order: 1 → 2 → 3 → 4.
- (3) Press [EDIT/SEND SET] button to complete the pairing setting.

After you turn the breaker ON, the remote controller that first sends a signal to an indoor unit will be regarded as the remote controller for the indoor unit. Once they are set, the indoor unit will only receive the signal from the assigned remote controller afterwards.

The setting of indoor unit will be canceled, if the breaker is turned OFF or the power supply is shut down.

## Setting the installation position

Be sure to set the remote controller in accordance with the installed position of the indoor unit.

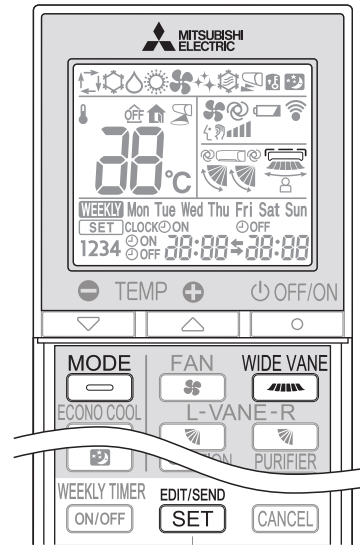

**Installation position:**

- Left: Distance to objects (wall, cabinet, etc.) is less than 50 cm to the left
- Center: Distance to objects (wall, cabinet, etc.) is more than 50 cm to the left and right
- Right: Distance to objects (wall, cabinet, etc.) is less than 50 cm to the right

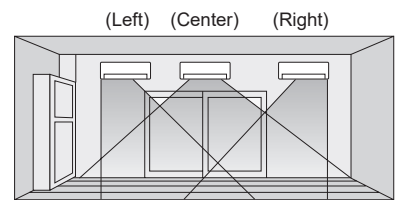

Area	Left	Center	Right
Remote controller display			

1 Hold down on the remote controller for 2 seconds to enter the position setting mode.

2 Select the target installation position by pressing .  
(Each press of the displays the positions in order:)

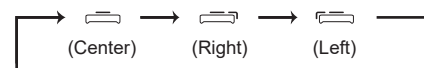

3 Press to complete the position setting.

**Note:**

- The installation position can be set only when all the following conditions are met:
- The remote controller is powered off.
  - Weekly timer is not set.
  - Weekly timer is not being edited.

# I-SEE Operation

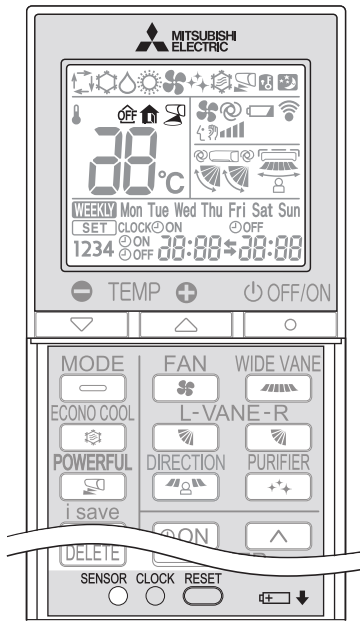

In the i-see control mode, the room temperature is controlled based on the sensible temperature.

**1** Press  during COOL, DRY, HEAT and AUTO mode to activate the i-see control mode.

- Press gently using a thin instrument.
-  lights. (Operation display section)
- The default setting is "active".

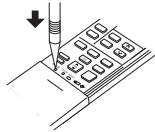

Press  several times to cancel the i-see control mode.

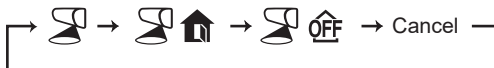

## Note:

### How to detect human presence

- When the air conditioner starts to operate, the i-see Sensor analyzes the temperature of a room by rotating clockwise and counterclockwise.
- Then, it detects human presence by their motion based on their heat signatures.



### Detection range

The i-see Sensor does not analyze the temperature in the following range.

- The wall surface on which the air conditioner is installed
- The spot beneath the air conditioner
- Where there is an object (such as furniture) between the place and the air conditioner

It might not detect human and objects properly on the following conditions

- When the temperature of the floor and the wall is high (such as when the air conditioner starts to operate in summer)
- When occupants are in blanket or wear heavily
- When there is an object whose temperature changes rapidly in a short time
- When windows and doors are small or they are far from the air conditioner
- When the sensor cannot detect the heat source such as of small kids or pets
- When using a floor heating or an electric carpet
- When occupants do not move after the air conditioner starts to operate

Refer to [page 9](#) "Absence Detection" for  and .

# Selecting Operation Modes

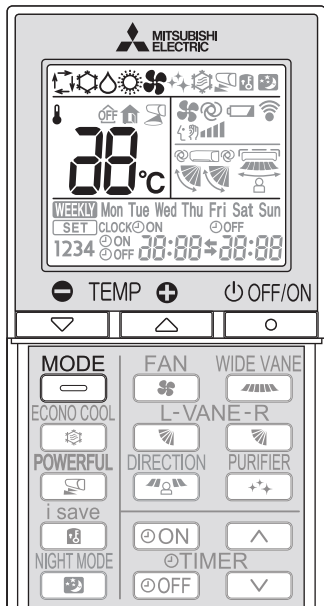

1 Press to start the operation.

2 Press to select operation mode. Each press changes mode in the following order:



3 Press to set the temperature. Each press raises or lowers the temperature by 1°C.

Press to stop the operation.

## Auto Mode (Auto Change Over)

The unit selects the operation mode according to the difference between the room temperature and the set temperature. During AUTO mode, the unit changes mode (COOL↔HEAT) when the room temperature is about 2°C away from the set temperature for more than 15 minutes.

**Note:**  
Auto Mode is not recommended if this indoor unit is connected to a MXZ type outdoor unit. When several indoor units are operated simultaneously, the unit may not be able to switch operation mode between COOL and HEAT. In this case, the indoor unit becomes standby mode (Refer to table of Operation indicator lamp).

## Cool Mode

Enjoy cool air at your desired temperature.

**Note:**  
Do not operate COOL mode at very low outside temperatures (less than -10°C). Water condensed in the unit may drip and wet or damage furniture, etc.

## Dry Mode

Dehumidify your room. The room may be cooled slightly. Temperature cannot be set during DRY mode.

## Heat Mode

Enjoy warm air at your desired temperature.

## Fan Mode

Circulate the air in your room.

**Note:**  
After COOL/DRY mode operation, it is recommended to operate in the FAN mode to dry inside the indoor unit.

**Note:**

**Multi system operation**  
Two or more indoor units can be operated by one outdoor unit. When several indoor units are operated simultaneously, cooling/dry/fan and heating operations cannot be done at the same time. When COOL/DRY/FAN is selected with one unit and HEAT with another or vice versa, the unit selected last goes into standby mode.

**Operation indicator lamp**  
The operation indicator lamp shows the operation state of the unit.

Indication	Operation state
	Standby mode (only during multi system operation)

Lit    Blinking



# Fan Speed and Airflow Direction Adjustment

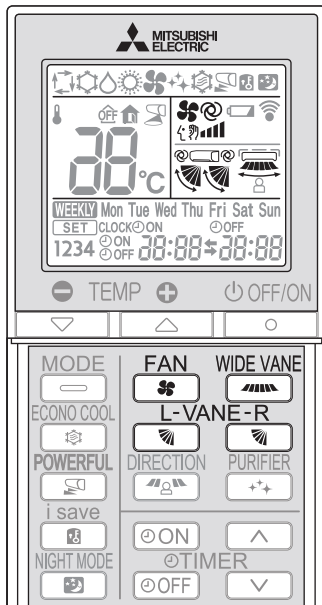

## Fan Speed

1 Press  to select fan speed. Each press changes fan speed in the following order:

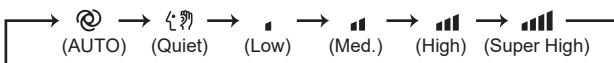

- Two short beeps are heard from the indoor unit when set to AUTO.
- Use higher fan speed to cool/heat the room quicker. It is recommended to lower the fan speed once the room is cool/warm.
- Use lower fan speed for quiet operation.

### Note:



#### Multi system operation

When several indoor units are operated simultaneously by one outdoor unit for heating operation, the temperature of the airflow may be low. In this case, it is recommended to set the fan speed to AUTO.

## Up-Down Airflow Direction

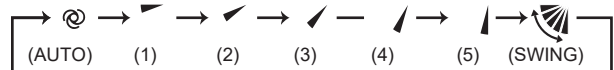
1 Press  to select airflow direction. Each press changes airflow direction in the following order:



-  (AUTO).....The vane is set to the most efficient airflow direction. COOL/ DRY/FAN: horizontal position. HEAT: position (4).
-  (Manual).....For efficient air conditioning, select the upper position for COOL/DRY, and the lower position for HEAT. If the lower position is selected during COOL/DRY, the vane automatically moves to the upward position (1) after 0.5 to 1 hour to prevent any condensation from dripping.
-  (Swing).....The vane moves up and down intermittently.
  - Two short beeps are heard from the indoor unit when set to AUTO.
  - Always use the remote controller when changing the direction of airflow. Moving the horizontal vanes with your hands causes them to malfunction.
  - When the breaker is turned on, the horizontal vanes' position will be reset in about a minute, then the operation will start. The same is true in the emergency cooling operation.
  - When the horizontal vanes seem to be in an abnormal position, see [page 16](#).
  - The right and left horizontal vanes set to the same level may not align perfectly.

## Left-Right Airflow Direction

1 Press  to select airflow direction. Each press changes airflow direction in the following order:

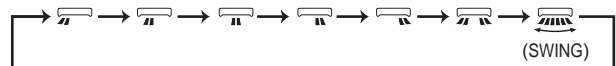

# Airflow Control Mode

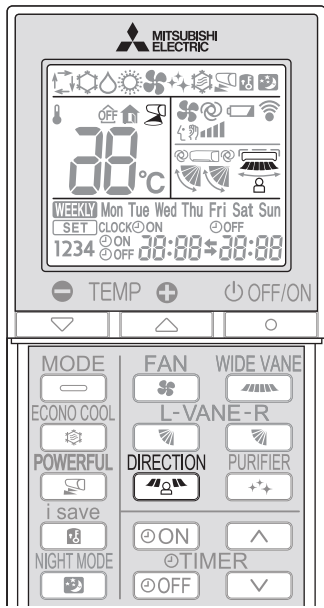

Airflow Control mode offers air conditioning according to a location of an occupant in a room detected by i-see Sensor.

**1** Press **DIRECTION** during COOL, DRY, HEAT or AUTO mode to activate the AIRFLOW CONTROL mode. This mode is only available when the i-see control mode is effective.

**2** Each press of **DIRECTION** changes AIRFLOW CONTROL in the following order:

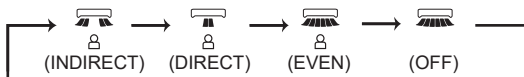

- (INDIRECT): An occupant will be less exposed to direct airflow.
- (DIRECT) : Mainly the vicinity of an occupant will be air-conditioned.
- (EVEN) : The unit learns the area where an occupant spend most of the time, and evens out the temperature of that area.

- Horizontal and vertical airflow directions will be automatically selected.
- When more than a couple of people are in a room, the AIRFLOW CONTROL mode may work less effectively.
- If you still feel uncomfortable with the air direction determined by the INDIRECT mode, adjust the air direction manually. **Page 8**

**Cancelling the i-see control mode automatically cancels the AIRFLOW CONTROL mode.**

- The AIRFLOW CONTROL mode is also cancelled when the VANE or WIDE VANE buttons is pressed.

# Absence Detection

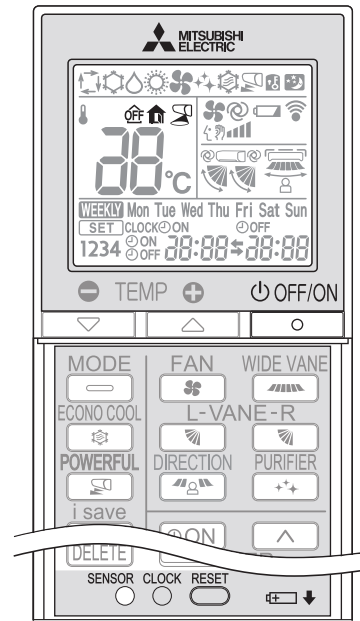

This function automatically changes the operation to No occupancy energy-saving mode or No occupancy Auto-OFF mode when nobody is in the room.

**1** To activate this No occupancy energy-saving mode, press **SENSOR** until appears on the operation display of the remote controller.

**2** To activate this No occupancy Auto-OFF mode, press **SENSOR** until **OFF** appears on the operation display of the remote controller.

Press **SENSOR** again to cancel the ABSENCE DETECTION.

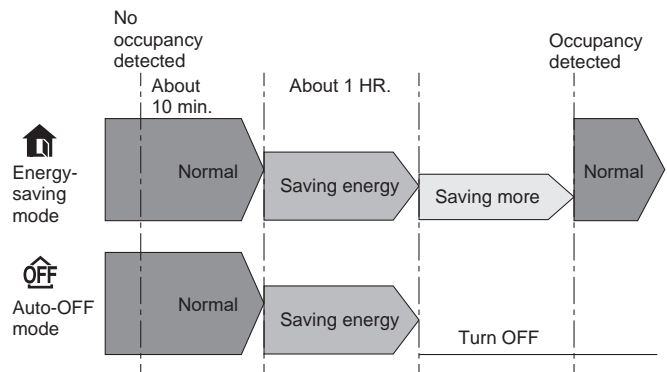
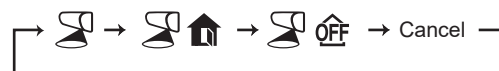

- Even if the unit is turned OFF due to No occupancy Auto-OFF mode, the display of the remote controller remains to indicate the unit is in operation. Press **OFF/ON** then press **OFF/ON** again to restart operation.
- When OFF timer is set, a priority is given to OFF timer.
- No occupancy energy saving mode or No occupancy Auto-OFF mode are not available during POWERFUL operation.
- The unit will not be turned off if no one is detected during normal operation mode, even though No occupancy Auto-OFF mode is activated.

# I-SAVE Operation

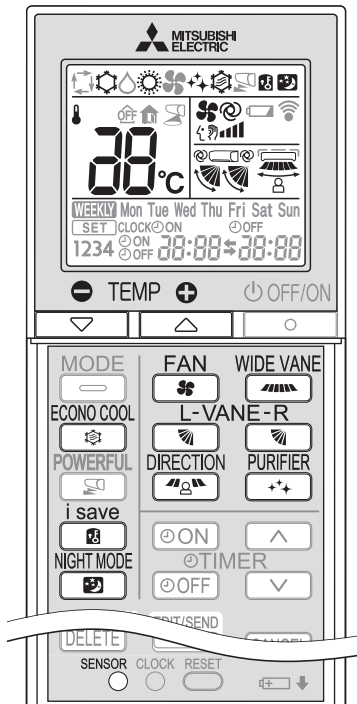

A simplified set back function enables to recall the preferred (preset) setting with a single push of the **i save** button. Press the button again and you can go back to the previous setting in an instance.

**1** Press **i save** during COOL, ECONO COOL, HEAT mode and NIGHT MODE operation to select i-save mode.

**2** Set the temperature, fan speed, and airflow direction.

- The same setting is selected from the next time by simply pressing **i save**.
- Two settings can be saved. (One for COOL/ECONO COOL, one for HEAT)
- Select the appropriate temperature, fan speed, and airflow direction according to your room.

Press **i save** again to cancel i-save operation.

- i-save operation also is cancelled when the MODE or POWERFUL button is pressed.

## Note:

Example of use:

### 1. Low energy mode

Set the temperature 2°C to 3°C warmer in COOL and cooler in HEAT mode. This setting is suitable for unoccupied room, and while you are sleeping.

### 2. Saving frequently used settings

Save your preferred setting for COOL, ECONO COOL, HEAT mode and NIGHT MODE operation. This enables you to select your preferred setting with a single push of the button.

# ECONO COOL Operation

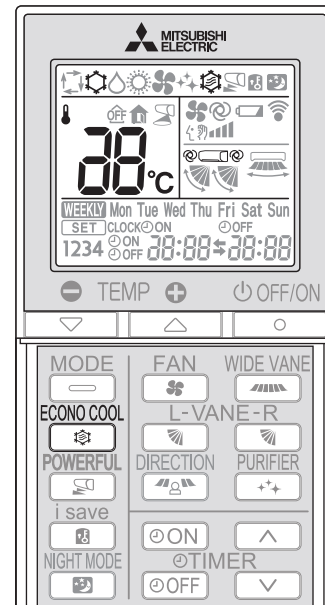

Swing airflow (change of airflow) makes you feel cooler than stationary airflow.

The set temperature and the airflow direction are automatically changed by the microprocessor. It is possible to perform cooling operation with keeping comfort. As a result energy can be saved.

**1** Press **ECONO COOL** during COOL mode **page 7** to start ECONO COOL operation.

The unit performs swing operation vertically in various cycles according to the temperature airflow.

Press **ECONO COOL** again to cancel ECONO COOL operation.

- ECONO COOL operation is also cancelled when the VANE or POWERFUL button is pressed.

# NIGHT MODE Operation

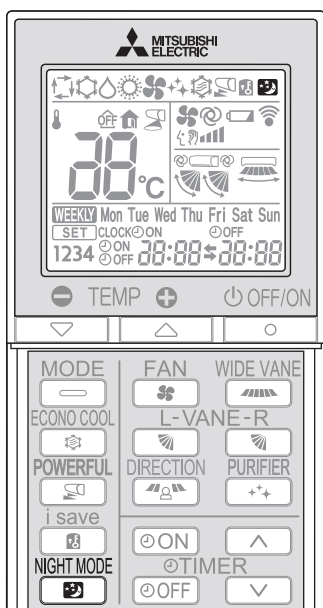

NIGHT MODE operation changes the brightness of the operation indicator, disables the beep sound and limits the noise level of the outdoor unit.

**1** Press  during operation to activate NIGHT MODE operation.

- The operation indicator lamp dims.
- The beep sound will be disabled except that emitted when the operation is started or stopped.
- Noise level of the outdoor unit will be lower than that mentioned in SPECIFICATIONS.

Press  again to cancel NIGHT MODE operation.

**Note:**

- Noise level of the outdoor unit may not change after start-up of the unit, during the protection operation, or depending on other operating conditions.
- The fan speed of the indoor unit will not change.
- The operation indicator lamp will be hard to be seen in a bright room.
- Operating POWERFUL operation during NIGHT MODE operation will increase the noise level of the outdoor unit.
- Noise level of the outdoor unit will not decrease during Multi system operation.

# Air Purifying Operation

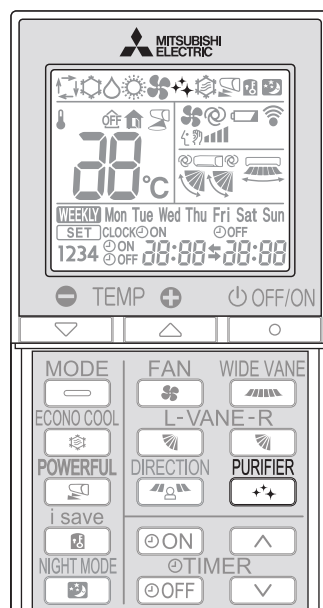

In the AIR PURIFYING operation, the indoor unit built-in device reduces airborne fungi, viruses, mold, and allergens.

**1** Press  to start AIR PURIFYING operation.  
• AIR PURIFYING lamp turns on. (Display section)

Press  again to cancel AIR PURIFYING operation.  
• AIR PURIFYING lamp turns off. (Display section)

**Note:**

- Never touch the air purifying device during operation. Although the air purifying device is safety-conscious design, touching this device could be the cause of trouble as this device discharge high voltage electricity.
- A "hissing" sound may be heard during the air purifying operation. This sound is produced when plasma is being discharged. This is not a malfunction.
- Air purifying lamp does not turn on if the front panel is not closed completely.

# Powerful Operation

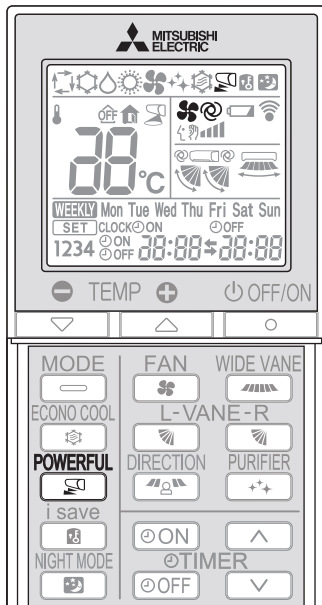

- 1 Press  during COOL or HEAT mode [page 7](#) to start POWERFUL operation.

Fan speed : Exclusive speed for POWERFUL mode  
 Horizontal vane : Set position, or downward airflow position during AUTO setting



- Temperature cannot be set during POWERFUL operation.

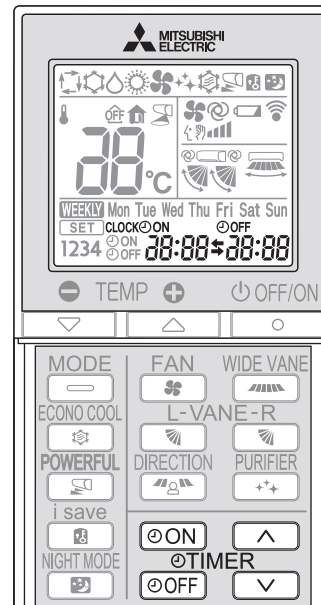

- Press  again to cancel POWERFUL operation.
- POWERFUL operation is also cancelled automatically in 15 minutes, or when the OFF/ON, FAN, ECONO COOL or i-save button is pressed.





# Timer Operation (ON/OFF Timer)



- 1 Press  or  during operation to set the timer.

 (ON timer) : The unit turns ON at the set time.  
 (OFF timer) : The unit turns OFF at the set time.

- \*  or  blinks.
- \* Make sure that the current time and day are set correctly. [Page 5](#)

- 2 Press  (Forward) and  (Backward) to set the time of timer.  
 Each press changes the set time 10 minutes forward/backward.  
 • Set the timer while  or  is blinking.

Press  or  again to cancel timer.

## Note:

- ON and OFF timers can be set together. ⚡ mark indicates the order of timer operations.
- If power failure occurs while ON/OFF timer is set, see [page 19](#) "Auto restart function".

# Weekly Timer Operation

- A maximum of 4 ON or OFF timers can be set for individual days of the week.
- A maximum of 28 ON or OFF timers can be set for a week.

E.g. : Runs at 24°C from waking up to leaving home, and runs at 27°C from getting home to going to bed on weekdays.  
Runs at 27°C from waking up late to going to bed early on weekends.

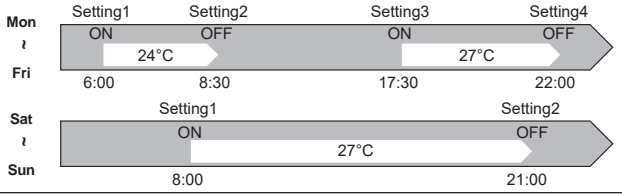

## Note:

The simple ON/OFF timer setting is available while the weekly timer is on. In this case, the ON/OFF timer has priority over the weekly timer; the weekly timer operation will start again after the simple ON/OFF timer is complete.

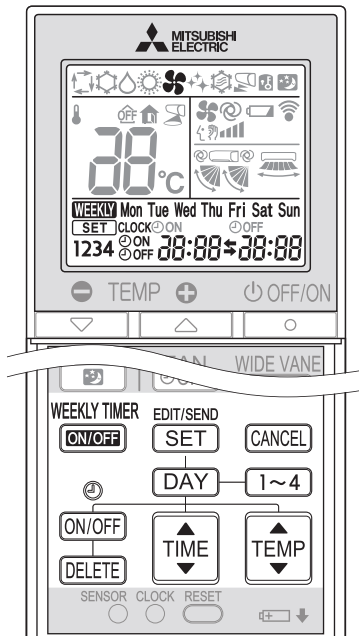

## Setting The Weekly Timer

\* Make sure that the current time and day are set correctly.

1 Press **EDIT/SEND SET** to enter the weekly timer setting mode.

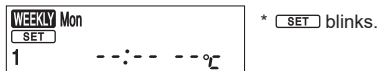

2 Press **DAY** and **1~4** to select setting day and number.

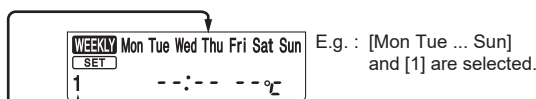

Pressing **DAY** selects the day of the week to be set.

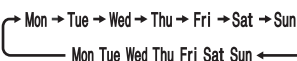

\* All days can be selected.

Pressing **1~4** selects the setting number.

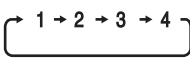

3 Press **ON/OFF**, **TIME**, and **TEMP** to set ON/OFF, time, and temperature.

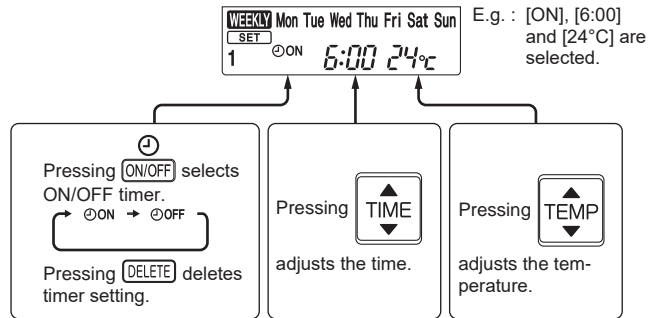

\* Hold down the button to change the time quickly.

Press **DAY** and **1~4** to continue setting the timer for other days and/or numbers.

4 Press **EDIT/SEND SET** to complete and transmit the weekly timer setting.



## Note:

- Press **EDIT/SEND SET** to transmit the setting information of weekly timer to the indoor unit. Point the remote controller toward the indoor unit for 3 seconds.
- When setting the timer for more than one day of the week or one number, **EDIT/SEND SET** does not have to be pressed per each setting. Press **EDIT/SEND SET** once after all the settings are complete. All the weekly timer settings will be saved.
- Press **EDIT/SEND SET** to enter the weekly timer setting mode, and press and hold **DELETE** for 5 seconds to erase all weekly timer settings. Point the remote controller toward the indoor unit.

5 Press **WEEKLY TIMER ON/OFF** to turn the weekly timer ON. (**WEEKLY** lights.)

\* When the weekly timer is ON, the day of the week whose timer setting is complete, will light.

Press **WEEKLY TIMER ON/OFF** again to turn the weekly timer OFF. (**WEEKLY** goes out.)

## Note:

The saved settings will not be cleared when the weekly timer is turned OFF.

## Checking Weekly Timer Setting

1 Press **EDIT/SEND SET** to enter the weekly timer setting mode.

\* **SET** blinks.

2 Press **DAY** or **1~4** to view the setting of the particular day or number.

Press **CANCEL** to exit the weekly timer setting.

## Note:

When all days of the week are selected to view the settings and a different setting is included among them, **--:-- --°C** will be displayed.

# Cleaning

## Instructions:

- Switch off the power supply or turn off the breaker before cleaning.
- Be careful not to touch the metal parts with your hands.
- Do not use benzine, thinner, polishing powder, or insecticide.
- When dirt stands out, wash it with kitchen neutral detergent diluted with lukewarm water to the specified concentration, then wipe off the detergent with a damp towel. Use only diluted mild detergents.
- Do not use a scrubbing brush, a hard sponge, or the like.
- Do not soak or rinse the horizontal vane.
- Do not use water hotter than 50°C.
- Do not expose parts to direct sunlight, heat, or fire to dry.
- Do not apply excessive force on the fan as it may cause cracks or breakage.

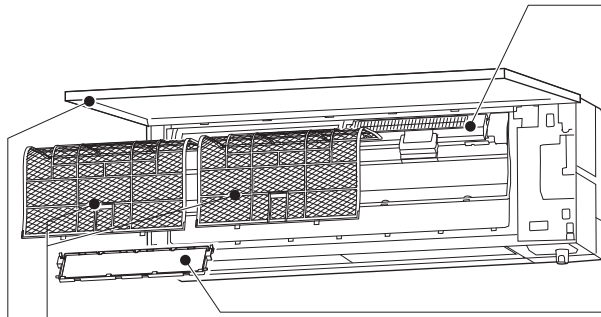

### Air filter

- **Clean every 2 weeks**
- Remove dirt by a vacuum cleaner, or rinse with water.
- After washing with water, dry it well in shade.

### Air purifying device

- Every 3 months:
- Remove dirt by a vacuum cleaner.
- When dirt cannot be removed by vacuum cleaning:**
- Soak the filter together with its frame in lukewarm water and rinse it.
  - After washing, dry it well in shade.

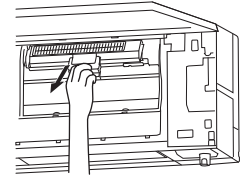

### Air cleaning filter (Deodorizing filter, black)

- Every 3 months:
- Remove dirt by a vacuum cleaner, or soak the framed filter in lukewarm water (30 to 40°C) for about 15 minutes. Rinse well.
  - After washing, dry it well in shade.
  - Deodorizing feature recovers by cleaning the filter.
- When dirt or smell cannot be removed by cleaning:**
- Replace it with a new air cleaning filter.
  - Parts Number **MAC-3010FT-E**

## Front panel

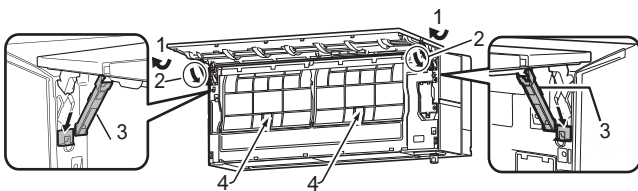

1. Open the front panel.  
Note: You cannot remove the front panel.
2. Rotate the stoppers as indicated by the arrows until they click.
3. Lower the front panel slowly and it will be held open with the stoppers.
4. Pinch the tabs on the filters; slightly push them up and pull down toward you to remove the filters.
5. Close the front panel securely and press the positions indicated by the arrows.
6. Clean the front panel without detaching it from the unit.
  - Wipe with a soft dry cloth.
  - Use the dedicated SOFT DRY CLOTH. Parts Number **MAC-1001CL-E**
  - Do not soak the front panel in water.

### ! Important

- **Clean the filters regularly for best performance and to reduce power consumption.**
- **Dirty filters cause condensation in the air conditioner which will contribute to the growth of fungi such as mold. It is therefore recommended to clean air filters every 2 weeks.**
- Do not touch the i-see sensor.
- **The air purifying device does not function for safety for a couple minutes after the operation starts or the front panel is opened/closed.**
- **Do not disassemble the air purifying device.**
- **Do not touch any parts other than the frame of the air purifying device.**

### ! Important

- **The surface of the indoor unit is easily scratched, so never rub or hit the unit with something hard. Also, when installing or removing the front panel, handle it with care to prevent scratches on it.**
- **Do not use abrasive cleaner to prevent scratches on the surface of the indoor unit.**
- **It is very easy to get fingerprints on the surface of the indoor unit. When fingerprints are noticeable, gently wipe them off with a soft dry cloth.**
- **When using a commercially available chemical impregnated cloth, follow its instructions.**
- **Do not leave the front panel open for a prolonged time.**

# Wi-Fi Interface Setting Up

This Wi-Fi interface, communicates the status information and controls the commands from the the server by connecting to an indoor unit.

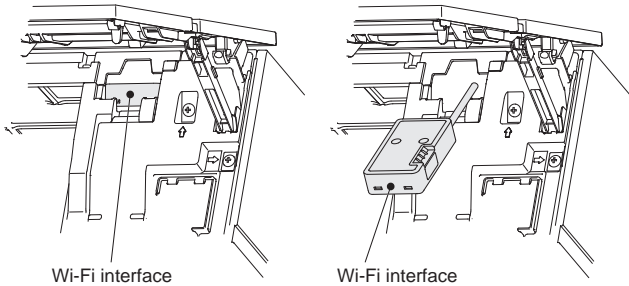

## Wi-Fi Interface Introduction

No	Item	Description
1	MODE Button	Selects modes.
2	RESET Button	Resets the system and ALL settings.
3	ERR LED (Orange)	Shows the network error state.
4	NET LED (Green)	Shows the network state.
5	MODE LED (Orange)	Shows the Access Point Mode state.
6	UNIT LED (Green)	Shows the indoor unit state.

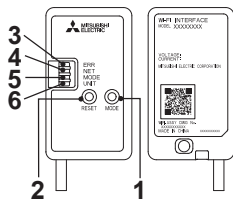

### (1) MODE Button

#### WPS-Push

- Hold down the MODE Button for 2 seconds to start WPS-Push Pairing.
- When WPS-Push is enabled on the Wi-Fi interface, the MODE LED starts flashing orange (every second) and the pairing can be completed by enabling WPS-Push on the Router.

#### Access Point Mode

- Hold down the MODE Button for 7 seconds to start Access Point Mode.
- When Access Point Mode is enabled on the Wi-Fi interface, the MODE LED starts flashing orange (every 5 seconds).
- To cancel Access Point Mode, hold down the MODE Button for 7 seconds again and ensure that the MODE LED is no longer flashing.

#### WPS-PIN

- Hold down the MODE Button for 15 seconds to start WPS-PIN Pairing.
- When WPS-PIN is enabled on the Wi-Fi interface, MODE LED starts flashing orange (every 0.5 seconds) and the pairing can be completed by enabling WPS-PIN on the Router.
- Before using WPS-PIN, the PIN code of the Wi-Fi interface needs to be set on the Router.

### (2) RESET Button

- Hold down the RESET Button for 2 seconds to reboot the system.
- Hold down the RESET Button for 15 seconds to initialise the Wi-Fi interface to the factory default.

### Note:

When the Wi-Fi interface is reset to the factory default, ALL the configuration information will be lost. Take great care in implementing this operation.

## Information for Users

The following steps explain how to connect the Wi-Fi interface to a Router.

**KEY (LED LIGHTS):** ● : ON ○ : OFF ✨ : Flashing

- 1 Ensure the Wi-Fi interface is connected correctly as per the previous section, 'Connecting the Wi-Fi interface'. UNIT LED should be flashing green only.

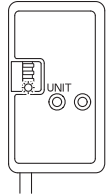

- 2 Download and install Wi-Fi Control App to your compatible Apple or Android smartphone/tablet (search term: Mitsubishi Wi-Fi Control).

## There are Two Options of Connecting

### Option 1 - Access Point Mode Pairing

- 3 Activate Access Point Mode on your Wi-Fi interface by using a small object to press and hold the MODE Button for 7 seconds.

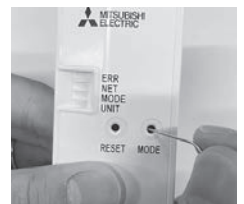

- 4 When Access Point Mode is enabled on the Wi-Fi interface, MODE LED starts flashing orange (every 5 seconds).

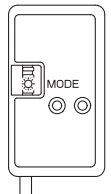

- 5 Check the label on the back of the interface for the SSID. Open the Wi-Fi networks screen on your smartphone/tablet and connect to the network with the same name as the SSID. The network password, labelled KEY, is just under the SSID on the interface.

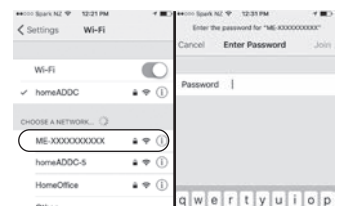

You will now be connected to this Wi-Fi interface

- 6 Open Wi-Fi Control App and follow the 'How to Setup' instructions in the 'Setup Wi-Fi interface' section. If the app does not go to this section, you are not connected to the Wi-Fi interface's Access Point; please start process again. You can either select your available Wi-Fi Network, or manually configure a Wi-Fi Network.





# Wi-Fi Interface Setting Up

**7** Once completed, the MAC and ID will be filled in 'Add new unit'. Select 'Add' and then control your heat pump via Wi-Fi.



**9** Open Wi-Fi Control App. Enter MAC and ID into 'Add new unit' and select 'Add'.



## Option 2 - WPS-Push Pairing

- Please Note: The WPS and Router reset buttons may be similar on some Routers.
- Please exercise caution as resetting your Router will erase network configuration.

**3** Check Wi-Fi and WPS are enabled on your Router. The connection procedure varies depending on your Router – refer to your Router's manual for more information.



**4** Activate WPS Mode on your Router. This will be enabled for a set period allowing approximately 2 minutes to complete the next step. To do so, please refer to your Router's manual.



**5** Activate WPS on your Wi-Fi interface by using a small object to press and hold the MODE Button for 2 seconds.

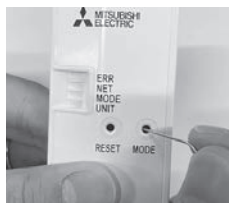

**6** When WPS-Push is enabled on the Wi-Fi interface, MODE LED starts flashing orange (every second).

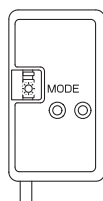

**7** When pairing process is completed on the Wi-Fi interface, the NET LED lights up solid green for 5 seconds.

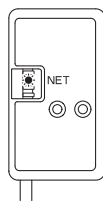

**8** If ERR LED lights up orange for 5 seconds at any stage, there may be a problem; please start process again.

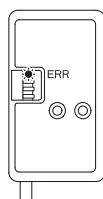

**10** Once completed, control your heat pump via Wi-Fi.



## LED Pattern

☀ : ON   ○ : OFF   ✨ : Flashing

• Software initialising				
Description	ERR (Orange)	NET (Green)	MODE (Orange)	UNIT (Green)
Firmware updating	○	☀	☀	○
Firmware downloading	○	✨ (every second)	✨ (every second)	○
Reset to the factory default	○	○	☀	☀
• Wireless setting				
Description	ERR (Orange)	NET (Green)	MODE (Orange)	UNIT (Green)
Access Point Mode activated	○	○	✨ (every 5 sec)	☀ (every 5 sec)
WPS-PUSH Mode activated	○	○	☀ (every second)	○
WPS-PIN Mode activated	○	○	☀ (every 0.5 sec)	○
Pairing process via WPS completed	○	☀ (5 sec)	○	○
Pairing process via WPS failed	☀ (5 sec)	○	○	○
• Connection to server in progress				
Description	ERR (Orange)	NET (Green)	MODE (Orange)	UNIT (Green)
Communicating with server, and starting up indoor unit communication	○	☀ (*1)	○	☀
Communicating with server, and communicating with indoor unit	○	☀ (*1)	○	☀ (every 5 sec)
• Normal operation				
Description	ERR (Orange)	NET (Green)	MODE (Orange)	UNIT (Green)
Communicating with server, and communicating with indoor unit	○	☀ (every 5 sec)	○	☀ (every 5 sec)

(\*1) Details of flash pattern

- Every 0.5 sec: Searching for server.
- Every second: Registering the information of the Wi-Fi interface to server.

# Wi-Fi Interface Setting Up

## Troubleshooting

☀ : ON ○ : OFF ✨ : Flashing

Description	ERR (Orange)	NET (Green)	MODE (Orange)	UNIT (Green)
Connection to server established, and connection to indoor unit failed	○	☀	○	○
Connection to Router failed, and connection to indoor unit established	○	○ (*3)	○	☀
Connection to Router failed, and starting up indoor unit connection	○	○ (*3)	○	☀
Connection to Router failed, and connection to indoor unit failed	○	○ (*3)	○	○
Connection to server failed, and connection to indoor unit established	☀ (*2)	☀	○	☀
Connection to server failed, and starting up indoor unit connection	☀ (*2)	☀	○	☀
Connection to server failed, and connection to indoor unit failed	☀ (*2)	☀	○	○

(\*2) Details of flash pattern

- Every 0.5 sec: IP address setting is invalid. Check DHCP Settings of the Router, or check IP address settings of the Wi-Fi interface. If both settings are correct but still the problem persists, push RESET Button for more than 15 seconds to retry the pairing.
- Every second: DNS setting is invalid. Check DNS Settings of the Router, or check DNS address settings of the Wi-Fi interface. If both settings are correct but still the problem persists, push RESET Button for more than 15 seconds to retry the pairing.
- Twice every 5 sec: Not connected to server. Check if the Router is connected to the internet.
- Once every 5 sec: Not communicating with server properly. Push RESET Button for 2 seconds.

(\*3) Details when NET LED is OFF

The Wi-Fi interface failed to connect to the Router. Check the following, and pair the Wi-Fi interface.

- Make sure that the communication distance is not too far between the Wi-Fi interface and the Router.
- Make sure 2.4GHz is enabled on dual band Routers.
- Make sure that the Router uses WPA2-PSK(AES) encryption.
- Make sure that the number of connected devices to the Router does not exceed the limit.
- Make sure that WPS is working on the Router.
- Make sure that the Router is compatible with the Wi-Fi interface.
- If Static IP has been set - make sure it is correct as per Router network settings.

If a problem regarding connecting your Router and the Wi-Fi interface persists, please contact your local Mitsubishi Electric office, as listed on the back of this guide. A list of compatible Routers is also available.

### Note:

- Ensure that the Router supports the WPA2-AES encryption setting before starting the Wi-Fi interface setup.
- The End user should read and accept the terms and conditions of the Wi-Fi service before using this Wi-Fi interface.
- To complete connection of this Wi-Fi interface to the Wi-Fi service, the Router may be required.
- This Wi-Fi interface will not commence transmission of any operational data from the system until the End user registers and accepts the terms and conditions of the Wi-Fi service.
- This Wi-Fi interface should not be installed and connected to any Mitsubishi Electric system which is to provide application critical cooling or heating.
- Please write down the information regarding the Wi-Fi interface setting on the last page of this manual, when you set up this Wi-Fi interface.
- At the time of relocation or disposal, reset the Wi-Fi interface to the factory default.

Mitsubishi Electric's Wi-Fi interface is designed for communication to Mitsubishi Electric's Wi-Fi service. Third party Wi-Fi interfaces cannot connect to Mitsubishi Electric's Wi-Fi service. Mitsubishi Electric is not responsible for any (i) underperformance of a system or any product; (ii) system or product fault; or (iii) loss or damage to any system or product; which is caused by or arises from connection to and/or use of any third party Wi-Fi interface or any third party Wi-Fi service with Mitsubishi Electric equipment.

For the latest information regarding Wi-Fi Control:

New Zealand based enquiries please visit: [www.mitsubishi-electric.co.nz/wifi](http://www.mitsubishi-electric.co.nz/wifi)

Australian based enquiries please visit: [www.mitsubishielectric.com.au/wifi](http://www.mitsubishielectric.com.au/wifi)

## Mitsubishi Electric Wi-Fi Heat Pump Control

### Register Your Heat Pump(s)

Thank you for choosing a Mitsubishi Electric Heat Pump with Wi-Fi Control. Once your Wi-Fi interface is installed, either download the app (search term: Mitsubishi Wi-Fi Control) or visit our website to register your heat pump(s).



Once registered you will be able to control your heat pump with your smartphone, tablet or online account using an internet connection.

(For a list of compatible devices, please visit the Mitsubishi Electric website).

### User Manual

A copy of the user manual, terms & conditions and privacy policy can be downloaded at any time from the Mitsubishi Electric website.

### Mitsubishi Electric New Zealand

[www.mitsubishi-electric.co.nz/wifi](http://www.mitsubishi-electric.co.nz/wifi)

Phone: 0800 639 434

### Mitsubishi Electric Australia

[www.mitsubishielectric.com.au/wifi](http://www.mitsubishielectric.com.au/wifi)

Phone: 1300 728 119



\*Apple and the Apple logo are trademarks of Apple Inc., registered in the U.S. and other countries. App Store is a service mark of Apple Inc., registered in the U.S. and other countries.

\*Google Play and the Google Play logo are trademarks of Google Inc.

# When You Think That Trouble has Occurred

Even if these items are checked, when the unit does not recover from the trouble, stop using the air conditioner and consult your dealer.

Symptom	Explanation & Check Points
<b>Indoor Unit</b>	
The unit cannot be operated.	<ul style="list-style-type: none"> <li>Is the breaker turned on?</li> <li>Is the power supply plug connected?</li> <li>Is the ON timer set? <a href="#">Page 12</a></li> </ul>
The horizontal vane does not move.	<ul style="list-style-type: none"> <li>Are the horizontal vane and the vertical vane installed correctly?</li> <li>Is the fan guard deformed?</li> <li>When the breaker is turned on, the horizontal vanes' position will be reset in about a minute. After the reset has completed, the normal horizontal vanes' operation resumes. The same is true in the emergency cooling operation.</li> </ul>
The unit cannot be operated for about 3 minutes when restarted.	<ul style="list-style-type: none"> <li>This protects the unit according to instructions from the microprocessor. Please wait.</li> </ul>
Mist is discharged from the air outlet of the indoor unit.	<ul style="list-style-type: none"> <li>The cool air from the unit rapidly cools moisture in the air inside the room, and it turns into mist.</li> </ul>
White smoke is discharged from the air inlet of the indoor unit.	<ul style="list-style-type: none"> <li>When the heating operation starts after the defrosting operation, vapor generated from the condensation on the heat exchanger looks like white smoke.</li> </ul>
The swing operation of the HORIZONTAL VANE is suspended for a while, then restarted.	<ul style="list-style-type: none"> <li>This is for the swing operation of the HORIZONTAL VANE to be performed normally.</li> </ul>
When SWING is selected in COOL/DRY/FAN mode, the lower horizontal vane does not move.	<ul style="list-style-type: none"> <li>It is normal that the lower horizontal vane does not move when SWING is selected in COOL/DRY/FAN mode.</li> </ul>
The airflow direction changes during operation. The direction of the horizontal vane cannot be adjusted with the remote controller.	<ul style="list-style-type: none"> <li>When the unit is operated in COOL or DRY mode, if the operation continues with air blowing down for 0.5 to 1 hour, the direction of the airflow is automatically set to upward position to prevent water from condensing and dripping.</li> <li>In the heating operation, if the airflow temperature is too low or when defrosting is being done, the horizontal vane is automatically set to horizontal position. Also the fan speed decreases or the fan stops.</li> </ul>
The operation stops for about 10 minutes in the heating operation.	<ul style="list-style-type: none"> <li>Outdoor unit is in defrost. Since this is completed in max. 10 minutes, please wait. (When the outside temperature is too low and humidity is too high, frost is formed.)</li> </ul>
The unit starts operation by itself when the main power is turned on, though it isn't operated with the remote controller.	<ul style="list-style-type: none"> <li>These models are equipped with an auto restart function. When the main power is turned off without stopping the unit with the remote controller and is turned on again, the unit starts operation automatically in the same mode as the one set with the remote controller just before the shutoff of the main power. Refer to "Auto restart function". <a href="#">Page 19</a></li> </ul>
The two horizontal vanes touch each other. The horizontal vanes are in an abnormal position. The horizontal vanes do not return to the correct "close position".	<p>Perform one of the following:</p> <ul style="list-style-type: none"> <li>Turn off and on the breaker. Make sure the horizontal vanes move to the correct "close position".</li> <li>Start and stop the emergency cooling operation and make sure the horizontal vanes move to the correct "close position".</li> </ul>
In COOL/DRY mode, when the room temperature reaches near the set temperature, the outdoor unit stops, then the indoor unit operates at low speed.	<ul style="list-style-type: none"> <li>When the room temperature deviates from the set temperature, the indoor fan starts running according to the settings on the remote controller.</li> </ul>
The indoor unit discolors over time.	<ul style="list-style-type: none"> <li>Although plastic turns yellow due to the influence of some factors such as ultraviolet light and temperature, this has no effect on the product functions.</li> </ul>
The ceiling and the walls around the indoor unit have smudges.	<ul style="list-style-type: none"> <li>It is because the ceiling and the walls get dust in the air due to air circulation by the air conditioner.</li> </ul>
Water leaks from the indoor unit.	<ul style="list-style-type: none"> <li>Is the front panel closed accurately? <a href="#">Page 14</a></li> <li>Does water flow smoothly from the edge of the drain hose?</li> </ul>
The operation indicator lamp is dim. The unit does not beep.	<ul style="list-style-type: none"> <li>Is the NIGHT MODE operation set?</li> </ul>
<b>Multi System</b>	
The indoor unit which is not operating becomes warm and a sound, similar to water flowing, is heard from the unit.	<ul style="list-style-type: none"> <li>A small amount of refrigerant continues to flow into the indoor unit even though it is not operating.</li> </ul>
When heating operation is selected, operation does not start right away.	<ul style="list-style-type: none"> <li>When operation is started during defrosting of outdoor unit is done, it takes a few minutes (max. 10 minutes) to blow out warm air.</li> </ul>

Symptom	Explanation & Check Points
<b>Outdoor Unit</b>	
The fan of the outdoor unit does not rotate even though the compressor is running. Even if the fan starts to rotate, it stops soon.	<ul style="list-style-type: none"> <li>When the outside temperature is low during cooling operation, the fan operates intermittently to maintain sufficient cooling capacity.</li> </ul>
Water leaks from the outdoor unit.	<ul style="list-style-type: none"> <li>During COOL and DRY operations, pipe or pipe connecting sections are cooled and this causes water to condense.</li> <li>In the heating operation, water condensed on the heat exchanger drips down.</li> <li>In the heating operation, the defrosting operation makes ice forming on the outdoor unit melt and drip down.</li> </ul>
White smoke is discharged from the outdoor unit.	<ul style="list-style-type: none"> <li>In the heating operation, vapor generated by the defrosting operation looks like white smoke.</li> </ul>
<b>Remote Controller</b>	
The display on the remote controller does not appear or it is dim. The indoor unit does not respond to the remote control signal.	<ul style="list-style-type: none"> <li>Are the batteries exhausted? <a href="#">Page 5</a></li> <li>Is the polarity (+, -) of the batteries correct? <a href="#">Page 5</a></li> <li>Did you press the reset button after replacing the batteries? <a href="#">Page 5</a></li> <li>Is the setting of multiple indoor units' installation the same as before replacing the batteries? <a href="#">Page 5</a></li> <li>Are any buttons on the remote controller of other electric appliances being pressed?</li> <li>The indoor unit may not receive the signal well depending on the condition in the room. Get close to the indoor unit and operate the remote controller.</li> </ul>
The operation mode cannot be changed.	<ul style="list-style-type: none"> <li>Disable the OPERATION LOCK.</li> </ul>
<b>Does not Cool or Heat</b>	
The room cannot be cooled or heated sufficiently.	<ul style="list-style-type: none"> <li>Is the temperature setting appropriate? <a href="#">Page 7</a></li> <li>Is the fan setting appropriate? Please change fan speed to High or Super High. <a href="#">Page 8</a></li> <li>Are the filters clean? <a href="#">Page 14</a></li> <li>Is the fan or heat exchanger of the indoor unit clean? <a href="#">Page 14</a></li> <li>Are there any obstacles blocking the air inlet or outlet of the indoor or outdoor unit?</li> <li>Is a window or door open?</li> <li>It may take a certain time to reach the setting temperature or may not reach that depending on the size of the room, the ambient temperature, and the like.</li> <li>Is the NIGHT MODE operation set?</li> </ul>
The room cannot be cooled sufficiently.	<ul style="list-style-type: none"> <li>When a ventilation fan or a gas cooker is used in a room, the cooling load increases, resulting in an insufficient cooling effect.</li> <li>When the outside temperature is high, the cooling effect may not be sufficient.</li> </ul>
The room cannot be heated sufficiently.	<ul style="list-style-type: none"> <li>When the outside temperature is low, the heating effect may not be sufficient.</li> </ul>
Air does not blow out soon in the heating operation.	<ul style="list-style-type: none"> <li>Please wait as the unit is preparing to blow out warm air.</li> </ul>
<b>Airflow</b>	
The air from the indoor unit smells strange.	<ul style="list-style-type: none"> <li>Are the filters clean? <a href="#">Page 14</a></li> <li>Is the fan or heat exchanger of the indoor unit clean? <a href="#">Page 14</a></li> <li>The unit may suck in an odor adhering to the wall, carpet, furniture, cloth, etc. and blow it out with the air.</li> </ul>
<b>Sound</b>	
Cracking sound is heard.	<ul style="list-style-type: none"> <li>This sound is generated by the expansion/contraction of the front panel, etc. due to change in temperature.</li> </ul>
"Bubbling" sound is heard.	<ul style="list-style-type: none"> <li>This sound is heard when the outside air is absorbed from the drain hose by turning on the range hood or the ventilation fan, making water flowing in the drain hose to spout out. This sound is also heard when the outside air blows into the drain hose in case the outside wind is strong.</li> </ul>
Mechanical sound is heard from the indoor unit.	<ul style="list-style-type: none"> <li>This is the switching sound in turning on/off the fan or the compressor.</li> <li>This is the sound of the i-See Sensor turning to the right and left.</li> </ul>
The sound of water flowing is heard.	<ul style="list-style-type: none"> <li>This is the sound of refrigerant or condensed water flowing in the unit.</li> </ul>
Hissing sound is sometimes heard.	<ul style="list-style-type: none"> <li>This is the sound when the flow of refrigerant inside the unit is changed.</li> </ul>
Heating operation stops and the sound is heard.	<ul style="list-style-type: none"> <li>The outdoor unit is defrosting. Heating operation starts after the frosty on the outdoor unit has been removed. This can take about 2 to 10 minutes.</li> <li>Cracking sound, Sound of water flowing, Hissing sound and Whistling sound are heard.</li> </ul>

# When You Think That Trouble has Occurred

Symptom	Explanation & Check Points
<b>Timer</b>	
Weekly timer does not operate according to settings.	<ul style="list-style-type: none"> <li>Is the ON/OFF timer set? <a href="#">Page 12</a></li> <li>Transmit the setting information of the weekly timer to the indoor unit again. When the information is successfully received, a long beep will sound from the indoor unit. If information fails to be received, 3 short beeps will be heard. Ensure information is successfully received. <a href="#">Page 13</a></li> <li>When a power failure occurs and the main power turns off, the indoor unit built-in clock will be incorrect. As a result, the weekly timer may not work normally. Be sure to place the remote controller where the signal can be received by the indoor unit. <a href="#">Page 5</a></li> </ul>
The unit starts/stops the operation by itself.	<ul style="list-style-type: none"> <li>Is the weekly timer set? <a href="#">Page 13</a></li> </ul>
<b>Others</b>	
The aluminum fin on the edge of the heat exchanger is discolored as if it is burnt.	<ul style="list-style-type: none"> <li>This is the coating resin discolored due to welding heat when the heat exchanger was being produced. The operation of the air conditioner is not the cause of the discoloration. It affects neither the performance of the heat exchanger nor the use of the air conditioner.</li> </ul>

In the following cases, stop using the air conditioner and consult your dealer.

- When water leaks or drips from the indoor unit.
- When the operation indicator lamp blinks.
- When the breaker trips frequently.
- The remote control signal is not received in a room where an electronic ON/OFF type fluorescent lamp (inverter-type fluorescent lamp, etc.) is used.
- Operation of the air conditioner interferes with radio or TV reception. An amplifier may be required for the affected device.
- When an abnormal sound is heard.
- When any refrigerant leakage is found.

# Emergency Operation

## When the remote controller cannot be used...

Emergency operation can be activated by pressing the emergency operation switch (E.O. SW) on the indoor unit.

Each time the E.O. SW is pressed, the operation changes in the following order:

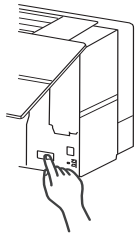

### Operation indicator lamp

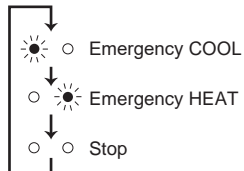

Set temperature : 24°C  
Fan speed : Medium  
Horizontal vane : Auto

### Note:

- The first 30 minutes of operation is test run. Temperature control does not work, and fan speed is set to High.
- In the emergency heating operation, the fan speed gradually rises to blow out warm air.
- In the emergency cooling operation, the horizontal vanes' position will be reset in about a minute, then the operation will start.

# Auto Restart Function

If a power failure occurs or the main power is turned off during operation, "Auto restart function" automatically starts operation in the same mode as the one set with the remote controller just before the shutoff of the main power. When timer is set, timer setting is cancelled and the unit starts operation when power is resumed.

**If you do not want to use this function, please consult the service representative because the setting of the unit needs to be changed.**

# When The Air Conditioner is not Going to be Used for a Long Time

- 1 Operate by COOL mode with the highest temperature set or FAN mode for 3 to 4 hours. **Page 7**
  - This dries the inside of the unit.
  - Moisture in the air conditioner contributes to favorable conditions for growth of fungi, such as mold.
- 2 Press  to stop the operation.
- 3 Turn off the breaker and/or disconnect the power supply plug.
- 4 Remove all batteries from the remote controller.

## When Using The Air Conditioner Again:

- 1 Clean the air filter. **Page 14**
- 2 Check that the air inlet and outlet of the indoor and outdoor units are not blocked.
- 3 Check that the earth is connected correctly.
- 4 Refer to the "PREPARATION BEFORE OPERATION", and follow the instructions. **Page 5**

# Installation Place and Electrical Work

## Installation Place

Avoid installing the air conditioner in the following places.

- Where there is much machine oil.
- Salty places such as the seaside.
- Where sulfide gas is generated such as hot spring, sewage, waste water.
- Where oil is splashed or where the area is filled with oily smoke (such as cooking areas and factories, in which the properties of plastic could be changed and damaged).
- Where there is high-frequency or wireless equipment.
- Where the air from the outdoor unit air outlet is blocked.
- Where the operation sound or air from the outdoor unit bothers the house next door.
- The mounting height of indoor unit 1.8 m to 2.3 m is recommended. If it is impossible, please consult your dealer.
- Do not operate the air conditioner during interior construction and finishing work, or while waxing the floor. Before operating the air conditioner, ventilate the room well after such work is performed. Otherwise, it may cause volatile elements to adhere inside the air conditioner, resulting in water leakage or scattering of dew.
- Do not use the Wi-Fi interface nearby the medical electrical equipment or people who have a medical device such as a cardiac pacemaker or an implantable cardioverter-defibrillator. It can cause an accident due to malfunctions of the medical equipment or device.
- This equipment should be installed and operated with a minimum distance of 20 cm between the device and the user or bystanders.
- Do not use the Wi-Fi interface nearby other wireless devices, microwaves, cordless phones, or facsimiles. It can cause malfunctions.
- The indoor unit must be installed in rooms which exceed the floor space specified. Please consult your dealer.

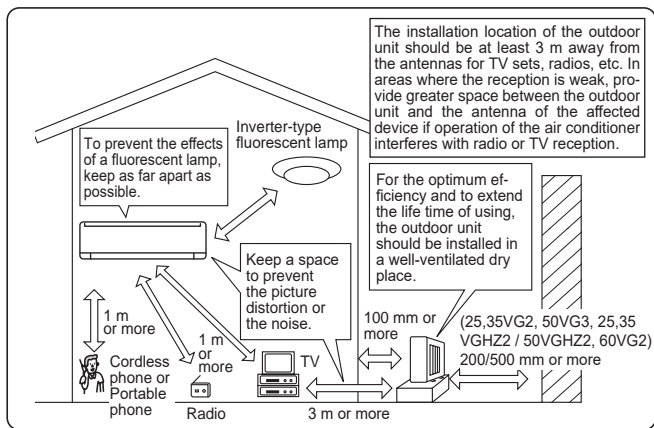

## Electrical Work

- Provide an exclusive circuit for the power supply of the air conditioner.
- Be sure to observe the breaker capacity.

If you have any questions, consult your dealer.

# Specifications

## Guaranteed Operating Range

		Indoor	Outdoor	
			LN25/35VG2 LN50VG3 LN60VG2	LN25/35VGHZ2 LN50VGHZ2
Cooling	Upper limit	32°C DB 23°C WB	46°C DB —	46°C DB —
	Lower limit	21°C DB 15°C WB	-10°C DB —	-10°C DB —
Heating	Upper limit	27°C DB —	24°C DB 18°C WB	24°C DB 18°C WB
	Lower limit	20°C DB —	-15°C DB -16°C WB	-25°C DB -26°C WB

DB: Dry Bulb  
WB: Wet Bulb

## Wi-Fi Interface

Model	MAC-578IF2-E
Input Voltage	DC12.7 V (from indoor unit)
Power consumption	MAX. 2 W
Size H×W×D (mm)	73.5×41.5×18.5
Weight (g)	46 (including cable)
Transmitter power level (MAX.)	17.5 dBm @IEEE 802.11b
RF channel	1ch ~ 13ch (2412~2472 MHz)
Radio protocol	IEEE 802.11b/g/n (20)
Encryption	AES
Authentication	WPA2-PSK
Software Ver	XX.00

## Wi-Fi Interface Setting Information

Indoor unit model name	
Indoor unit serial number	
Outdoor unit model name	
Outdoor unit serial number	
Wi-Fi interface MAC address (MAC)	
Wi-Fi interface serial number (ID)	
Wi-Fi interface PIN (PIN)	
Wi-Fi interface SSID (SSID)	
Wi-Fi interface KEY (KEY)	
System commissioning date	
Wi-Fi interface installation date	

## Installer contact details

Name	
Telephone number	



# **mitsubishi electric corporation**

HEAD OFFICE: TOKYO BUILDING, 2-7-3, MARUNOUCHI, CHIYODA-KU, TOKYO 100-8310, JAPAN

VG79Y699H01