



LOSSNAY HEAT RECOVERY VENTILATOR (RESIDENTIAL USE)

MODEL

**VL-250CZPVU2-R-EG, VL-250CZPVU2-L-EG
VL-350CZPVU2-R-EG, VL-350CZPVU2-L-EG
VL-500CZPVU2-R-EG, VL-500CZPVU2-L-EG**

Instruction Manual

For user

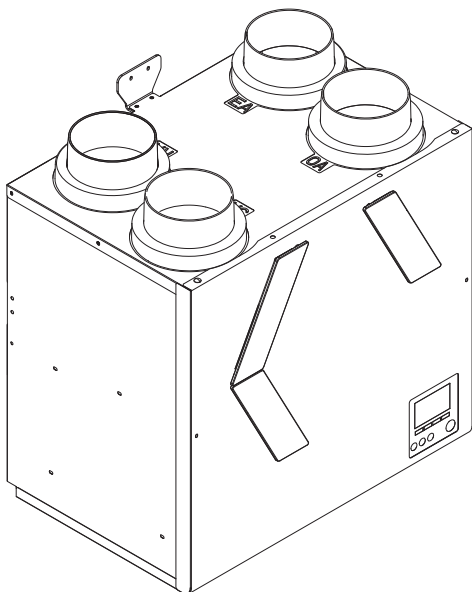

* The figure shows VL-350CZPVU2-R-EG

Contents



1. Safety Precautions	2
2. Features	4
3. Preparations Before Use	5
4. Names and Functions of Parts	6
5. How to Use	7
6. Maintenance	17
7. Troubleshooting	19
8. Specifications	21
9. After-Sales Service	22

Do not attempt to install the product by yourself. (Safety and proper functions of the product may not be assured.)







- This product is for residential use.
- To ensure correct and safe use, read the instruction manual thoroughly.
Before using the product, check **Safety Precautions** to use it correctly and safely.
- After reading, store the manual in a handy location for easy access.







1. Safety Precautions

The following symbols denote the type and degree of danger resulting from incorrect handling.



	WARNING		CAUTION
Incorrect handling of the product may result in serious injury or death.		Incorrect handling of the product may result in injury or damage to property or household effects.	

Symbols used in the text and on the main unit have the following meanings.

	Prohibited		Cannot be installed in a bathroom
	No disassembly		The product must be grounded
	No water exposure		Follow instructions

 WARNING	
 Prohibited	<p>Do not turn on or off the controller when corrosive gas has leaked. Sparks from electric contacts may cause the gas to explode.</p> <p>Do not use the product in hot places, in the direct sunlight and in smoky places. Failure to heed this warning may result in fire.</p>
 No disassembly	<p>Do not modify or disassemble the product using tools. Failure to heed this warning may result in fire, electric shock or injury.</p>
 No water exposure	<p>Refrain from immersing in water or splashing the product with water. Failure to heed this warning may result in fire or electric shock.</p>
 Cannot be installed in a bathroom	<p>Make sure that the product and the controller is not installed at a bathroom or other humid location. Failure to heed this warning may result in electric shock or injury.</p>
 The product must be grounded	<p>Make sure that the product is grounded. Device failure and electric leakage may cause electric shock. About installing a ground, contact your dealer or an electrical contractor.</p>
 Follow instructions	<p>Use 220 to 240 V AC power. Failure to heed this warning may result in fire, electric shock or damage to the circuit boards.</p> <p>Make sure that the outdoor air intake vent is located at a position where combustion gas or other similar gases is not sucked in. Inability to bring in fresh air may result in lack of oxygen in the room.</p> <p>Make sure to turn off the isolator before cleaning and maintenance. Failure to heed this warning may result in electric shock or injury.</p> <p>If an abnormality or malfunction occurs, immediately stop use of the product and device connected to, and turn off the circuit breaker on the power board. Continued use of the product in this state may result in odor, smoking, ignition fire, electric shock, or injury.</p> <p>Contact an electrical contractor to work electrical wiring. Incorrectly electrical work may result in electric shock.</p> <p>Make sure that an outdoor hood, that makes it less likely for rain water, snow or small animals (for example, bats) from entering, is installed at the ends of supply air and exhaust ducts. Failure to heed this warning may cause rain penetration, resulting in electric shock/fire or water damage to household property.</p> <p>If the product will not be operated for a long period of time, make sure to turn off the circuit breaker on the power board. Failure to heed this warning may result in electric shock due to deteriorated insulation or fire due to electric leakage.</p>

CAUTION

 Prohibited	<p>Do not use the product at locations where toxic gas or gas containing corrosive components such as acids, alkaline, organic solvents, or paints is generated. Failure to heed this warning may result in malfunction.</p> <p>During cleaning and maintenance, do not climb on an unstable stand. Injury may result if you tumble down.</p> <p>Do not use aerosol sprays (such as insect sprays, hair sprays or cleaners) on such as the unit. Failure to heed this warning may result in deterioration and damage to the parts.</p>
 Follow instructions	<p>Make sure that the product is installed horizontally. Water leakage may result in damage to property or household effects, and injury may result if the product should fall.</p> <p>Make sure that drain piping is installed at the discharge outlet.</p> <p>Wear gloves during cleaning and maintenance. Failure to heed this warning may result in injury.</p> <p>When removing the outdoor air filter case and exhaust filter case, dew condensation water that has built up indoor sometimes drips. So, remove the filter cases gently by supporting them with both hands so that they are not tilted.</p> <p>Securely install the parts after cleaning and maintenance. Injury may result if the parts should fall.</p> <p>Other than EU countries: This appliance is not intended for use by persons (including children) with reduced physical sensory or mental capabilities, or lack of experience and knowledge, unless they have been given supervision or instruction concerning use of the appliance by a person responsible for their safety. Children should be supervised to ensure that they do not play with the appliance.</p> <p>EU countries: This appliance can be used by children aged from 8 years and above and persons with reduced physical, sensory or mental capabilities or lack of experience and knowledge if they have been given supervision or instruction concerning use of the appliance in a safe way and understand the hazards involved. Children shall not play with the appliance. Cleaning and user maintenance shall not be made by children without supervision.</p>

Requests on Use

- When this product ventilates, it takes in cold air from the outdoor in winter. For this reason, when the outdoor air temperature drops, moisture in the air around the product condensates, and water drops sometimes adhere to the product or drop. This, however, is not a malfunction. Wipe off any water droplets.
- When outdoor air temperatures are low and operation of the product is stopped, operation of the ventilator or pressure of the outdoor wind might cause outdoor air to flow in from the product, which may result in dew condensation forming on the product and other parts. This is not a malfunction. Wipe off any water droplets.
- When a lot of humidity is generated from building materials at newly built houses, dew condensation may occur on the product and other parts. This is not a malfunction. Wipe off any water droplets.
- When a strongly fragrant scent, etc. is used in toilets, bath rooms and wash basins, or when cigarette or other smoke is discharged, odor is sometimes sense from the air vent.
- When ventilating a bathroom and living room etc. , operate the product for 24 hours.
- Do not stop operation except in the following instances. (Resume operation after the product has been temporarily stopped.)
 - When there is heavy snow, strong winds or heavy rain such as snowstorms or typhoons
 - When there is thick fog
 - During cleaning and maintenance
- When a lot of humidity is generated from building materials at newly built houses, dew condensation may form on the product and other parts. So, switch the operation mode to temporarily stop operation, and open the windows.

2. Features

What is the LOSSNAY HEAT RECOVERY VENTILATOR...?

- ◆ Effective ventilation routes can be achieved in the entire house by the supply air vent and the exhaust vent being installed at locations away from each other depending on the duct connection method.
- ◆ Built-in filters reduce the influx of dust, pollen, etc, in outdoor air before the air is supplied to rooms.

Heat exchange operation

Dirty air from the room is discharged (=exhaust), and clean air from the outdoor is taken into the room (=air supply). During this time, air is discharged and taken in through the Heat exchanger. As a result, air is ventilated while reusing (heat collection) the warmth or coolness of the room which is discarded during ventilation.

- ◆ When air conditioning is used in summer and winter, heat exchange ventilation reduces the load placed on air conditioning to ensure energy savings.

Bypass operation

When exhaust and air supply are performed, air is supplied to the room without any change in the outdoor air temperature due to exhaust being performed without passing through the Heat exchanger.

- ◆ In spring and fall, and summer nights, for example, the cool air of the outdoor is taken in.

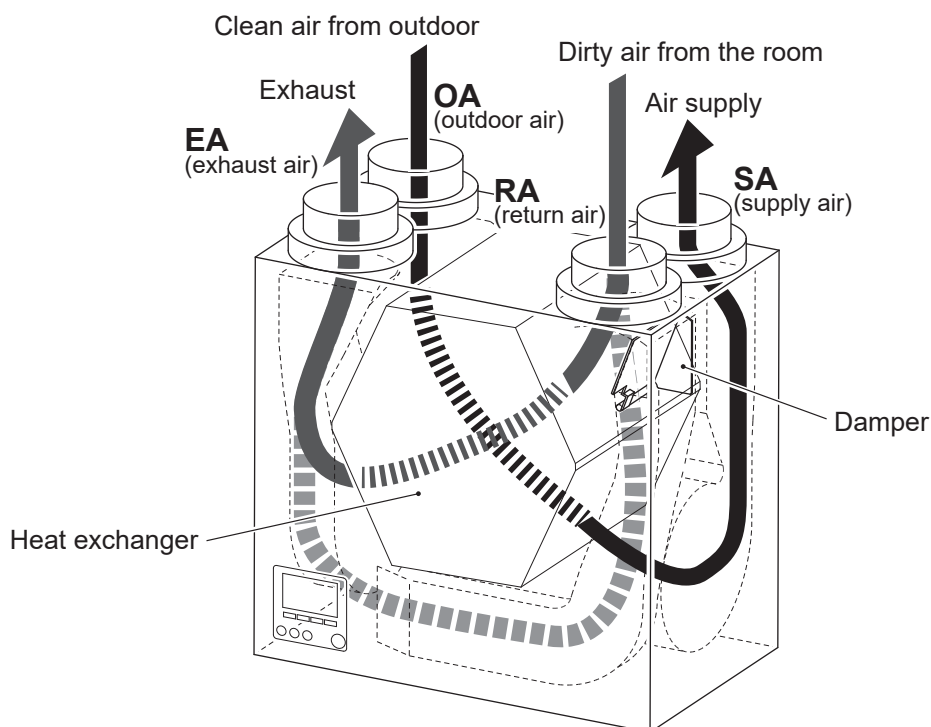

* The figure shows VL-350CZPVU2-L-EG

Note

- Ventilation is conducted at the ventilation air volume (Base Notch) required for the residence.
- By setting to Boost/Purge, the ventilation air volume is increased temporary to quickly ventilate the air.
- In the long absence, use the Holiday mode to save energy by reducing the fan output.

3. Preparations Before Use

■ **Receive an explanation about operation procedures and the correct method of use to ensure safe operation.**

Make sure that commissioning and operation checks described in the Installation Manual have been carried out.

■ **Check the positions and operation methods.**

1) Inspection space:

It is required for maintenance on the product.

The product requires maintenance (regular filter cleaning, internal motor replacement, etc.).

If the product position is out of the specified dimensions as a result of checking the inspection layout drawing described in the Installation Manual section 3.2 *Working space*, contact a distributor or an electrician.

2) Grills:

They are required on the supply air and exhaust sides of the product.

To reduce the frequency of cleaning the filters on the product, we recommend using a filter for taking up dust in the room in the exhaust grill.

3) Controller:

It is required for starting and stopping operation of the product and for switching the fan speed.

Please see section 5. *How to use*.

Note

- The product is not an air-conditioner.
- We recommend local ventilation for discharge cigarette smoke, etc.
- We recommend installing beds away from the supply air vent. (During sleep, you may be bothered by the operating sound of the product or feel cold air.)

4. Names and Functions of Parts

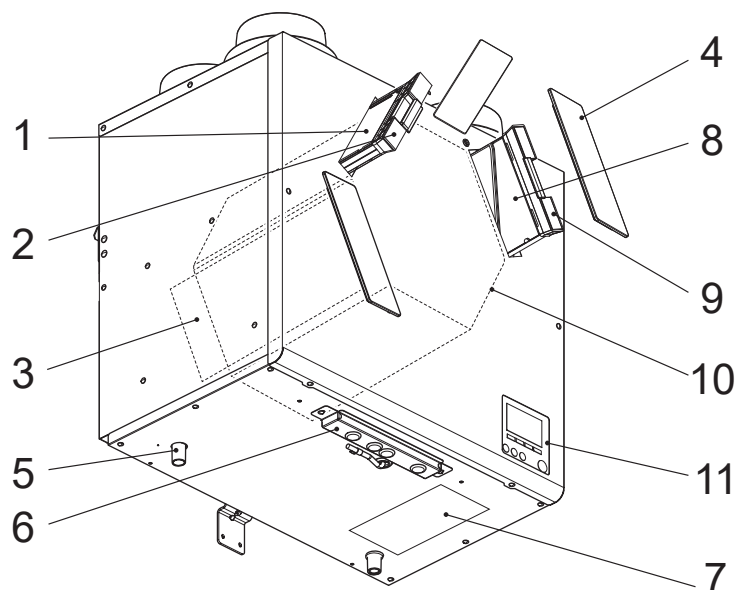

* The figure shows VL-350CZPVU2-R-EG

- On L-type (for example, VL-350CZPVU2-L-EG), filters, controller and name plate are on the reflected positions.

No.	Name	Function
1	Exhaust air filter	It prevents heat exchanger from clogging.
2	Exhaust air filter case	It holds the exhaust air filter
3	Optional air filter case	For optional filter*
4	Filter cover	-
5	Drain pipe attachment	It is connected to drain pipe.
6	Control box	It holds circuit board
7	Name plate	It shows product name and serial No.
8	Outdoor air filter	It removes insects, pollen, dirt, dust, and other particles from the outdoor air that is taken into the room.
9	Outdoor air filter case	It holds the outdoor air filter.
10	Heat exchanger	It exchanges heat between the supply air and the return air.
11	Controller	Product operation, See section 5.

* Optional filter

Filter name	MODEL	Applicable model	Maintenance interval	Location to use	
Standard filter	P-250SF-E	VL-250CZPVU series	1 year	RA, OA, SA	
	P-350SF-E	VL-350CZPVU series			
	P-500SF-E	VL-500CZPVU series			
Medium efficiency filter	P-250MF-E	VL-250CZPVU series	1 year	RA, OA, SA	
	P-350MF-E	VL-350CZPVU series			
	P-500MF-E	VL-500CZPVU series			
PM2.5 filter	P-250PF-E	VL-250CZPVU series	For SA installation: 1 year For OA or RA installation: 6 months	RA, OA, SA	
	P-350PF-E	VL-350CZPVU series			
	P-500PF-E	VL-500CZPVU series			
PM1 filter	P-250PFH-E	VL-250CZPVU series	For SA installation: 1 year For OA or RA installation: 6 months	RA, OA, SA	
	P-350PFH-E	VL-350CZPVU series			
	P-500PFH-E	VL-500CZPVU series			
NOx filter	P-250NF-E	VL-250CZPVU series	6 months	SA	RA: Return Air OA: Outdoor Air SA: Supply Air
	P-350NF-E	VL-350CZPVU series			
	P-500NF-E	VL-500CZPVU series			

* When a NOx filter and an optional dust catch filter (P-250/350/500SF-E, P-250/350/500MF-E, P-250/350/500PF-E, P-250/350/500PFH-E) are used together, make sure to install a NOx filter on the SA side and a dust catch filter on the OA side.

* Install any of the filters other than NOx filter on the OA and RA side to protect the product.

* Standard filter is the same as the filter which is originally installed in VL-***-EG series.

5. How to Use

■ Names and functions of controller components

Controller interface

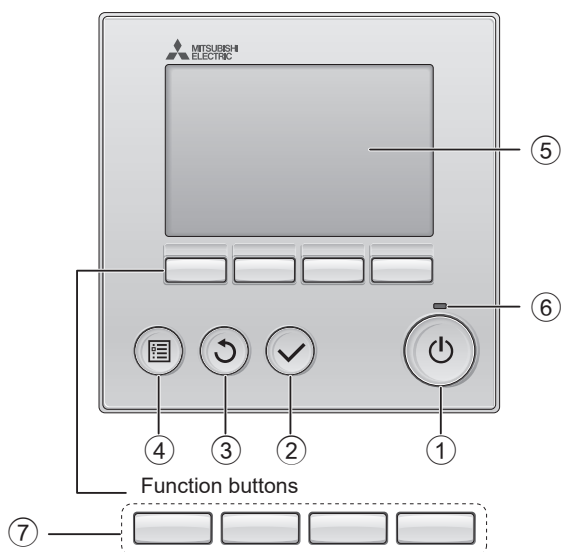

- ① ON/OFF button
Off operation is disabled at the factory default setting.
- ② SELECT button
- ③ RETURN button
- ④ MENU button
The «Main menu» screen is displayed.

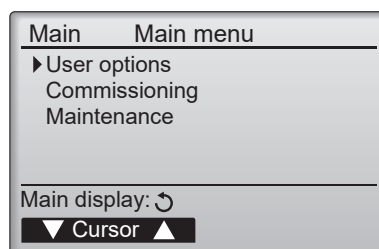

⑤ Backlit LCD

The screen displays operation settings.

Press any button to turn on the backlight.

You will be able to operate buttons.

After turning on the backlight for a certain period of time, the backlight turns off.

⑥ ON/OFF lamp

This lamp lights up in green while the product is operated.

It blinks in green, while the product has an error.

⑦ Function buttons (F1, F2, F3, F4)

Use to select each settings on each screen.

The functions of the buttons change depending on the screen.

See the function button guide at the bottom of the screen.

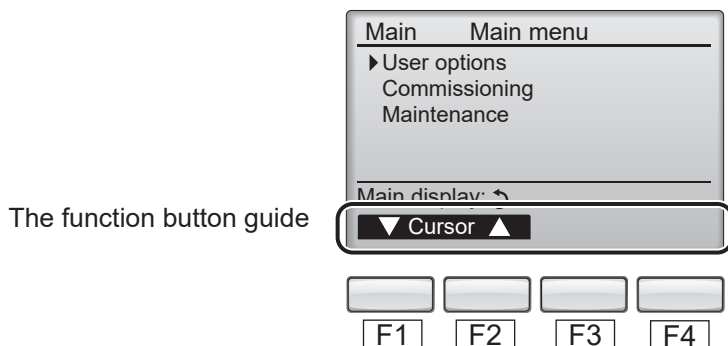

The function button guide

If any function is not in the function button, the function button guide is not displayed.

Display

* All icons are displayed for explanation.

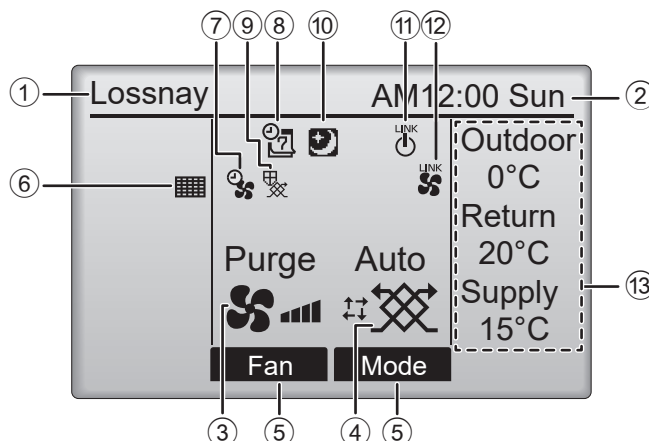

① Controller name

Lossnay is always displayed.

② Clock

Current time and appear weekday here.

③ Fan speed

Fan speed setting appears here.

④ Ventilation mode

Ventilation mode setting appears here.

⑤ Function button guide

Functions of the corresponding buttons appear here.

⑥

Appears when the filter maintenance time comes.

⑦

Appears when the Boost/Purge preset, or the Manual bypass mode function is enabled.

⑧

Appears when the Holiday mode is enabled.

⑨

Appears when performing to protect the Heat exchanger.
(Adjusting air volumes or operating Preheater)

⑩

Appears when the Silent mode is enabled.

⑪

This is displayed while linking with the air conditioner.

⑫

This is displayed when the Fan speed is fixed by the external input.

⑬ Outdoor, Return, Supply temperature, Return humidity, Return CO₂ temperature

The outdoor air temperature, return air (= extract) temperature, and supply air temperature are displayed. (The outdoor air temperature and the return air temperature are measured by the product built-in sensor.

- Since this product is not a measuring instrument, there is a possibility that an difference may occur with the local thermometer. The supply air temperature shows the calculated values.) It is not displayed in the factory default settings.

If you want to change the settings, please see 6.4.2.4 *Display details* of Installation Manual.

- By using the optional sensors, it will be able to display CO₂ concentration and humidity.

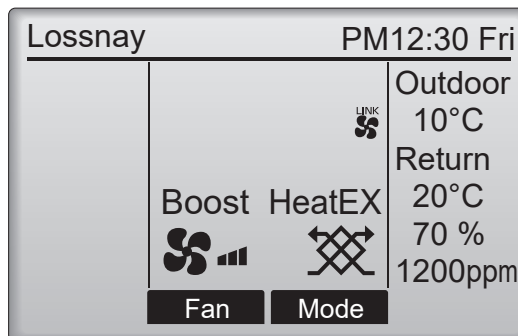

Basic operations

Power ON/OFF

ON



Press the button.

The ON/OFF lamp will light up in green, and the operation will start.

OFF

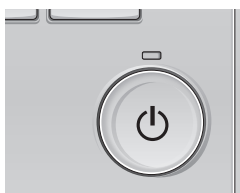

Press the button again.

The ON/OFF lamp will go out, and the operation will stop.

- OFF operation is disabled in the factory default settings. Therefore, if you turn on the power for the first time, you cannot turn it off with this button.
- If you want to enable the OFF operation, see the Installation Manual section 6.4.2.7.

Fan speed

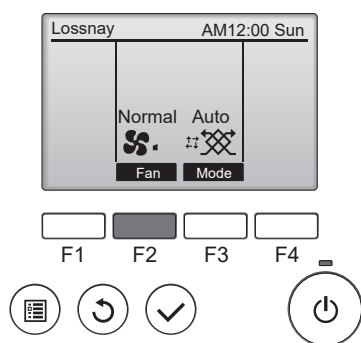

Press the **[F2]** button to change the fan speed in the following order.

Normal Medium Boost Purge



You can hide [Normal], [Medium], [Boost], [Purge] displayed above the Fan speed icon by the controller.

To change the setting, please check 6.4.2.7 *Control mode of Installation Manual*.

Note

Base notch: The [Base notch] is the fan speed of standard for constant ventilation.

The base notch is set to fan speed 1 at the factory default settings.

During [Boost] and [Purge], is shown. After a certain period of time, the fan speed will return to the [Base notch].

To change the [Base notch] setting, please see Installation Manual section 6.5.1.

Ventilation mode

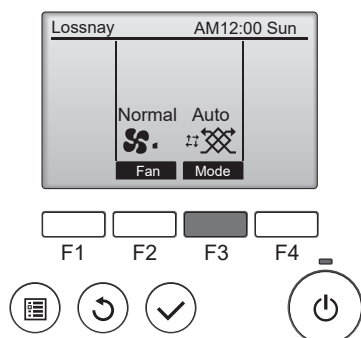

Press the **[F3]** button to go through the Ventilation mode in the following order.

Auto / Auto HeatEX Bypass



You can hide [Auto], [HeatEX], [Bypass] displayed above the Ventilation mode by the controller. See the Installation Manual section 6.4.2.

Under factory default settings, bypass operation cannot be selected from «Main display». Use the Manual Bypass mode if you want to bypass operation at any timing. See the Installation Manual section 6.4.2.7.

Icon	Function
Auto / Auto 	It automatically switches between heat exchange mode and bypass mode by temperature detection. To switch the temperature, please see the Installation Manual 6.4.4 <i>Auto bypass</i> .
HeatEX 	Heat exchange mode
Bypass 	Bypass mode.

■ Controller operation-Function settings

Menu composition

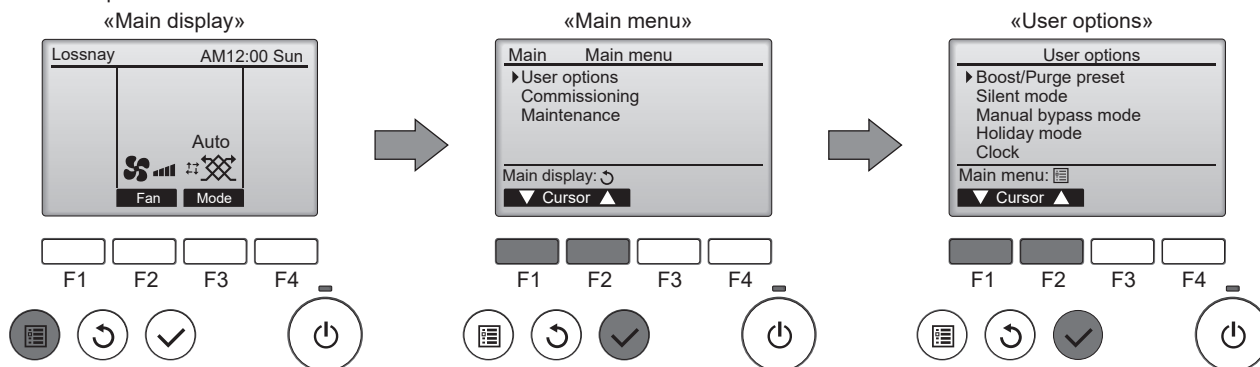

Main functions

	Function name	Function	Setting method and operation description	Detailed setting method
1	Boost/Purge preset	Turns off the Boost/Purge timer.	«Main display» Select the ventilation air volume or . Operation description: Returns to the base notch after a certain time of operation.	Instruction Manual: Section 5 <i>Boost/Purge preset.</i>
2	Silent mode	Prevents the noise at night.	«Main menu», «User options» Set weekdays and On/Off times. Operation description: Does not receive any external input during the specified period.	Instruction Manual: Section 5 <i>Silent mode.</i> Installation Manual: Section 6.4.5.
3	Manual bypass mode	Changes the bypass ventilation timer.	«Main display» In the ventilation mode, select the bypass mode. Operation description: Returns to the heat exchange mode after a certain time.	Instruction Manual: Section 5 <i>Manual bypass mode.</i> Installation Manual: Section 6.4.2.7.
4	Holiday mode	Saves energy in the long absence.	«Main menu», «User options» Select the Holiday mode. Operation description: Operates with small air volumes	Instruction Manual: Section 5 <i>Holiday mode.</i>
5	Filter Maintenance indicator	Shows a filter cleaning sign at regular intervals set by the contractor.	«Main menu», «Maintenance» Reset the notification timing after cleaning the filters.	Instruction Manual: Section 5 <i>Filter information.</i> Installation Manual: Section 6.4.11.

Clock

Button operation

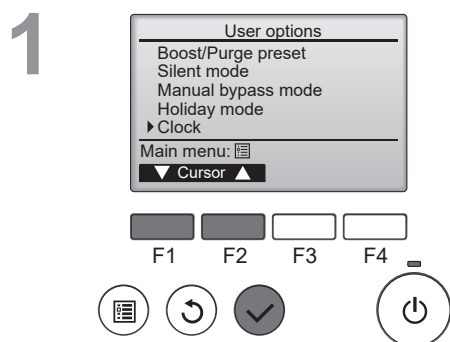

Select [User options] from the «Main menu» screen, and press the button.

Select [Clock] and press the button.

Note
Clock setting is required before making the following settings.

- Boost/Purge preset
- Silent mode
- Manual bypass mode
- Holiday mode

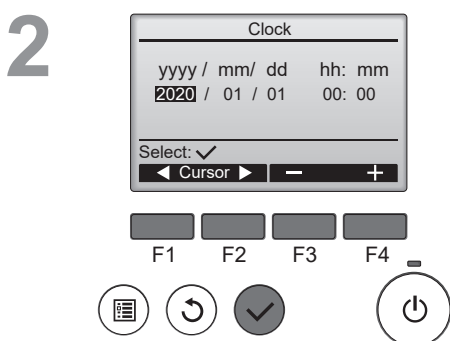

Increase or decrease the value, and press the button. A confirmation screen will appear.



Navigating through the screens

- To go back to the «Main menu» screen
- To return to the previous screen

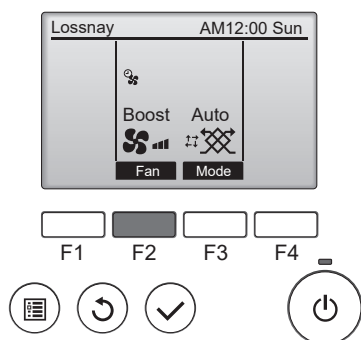
Boost/Purge preset



The Boost/Purge preset is the function that automatically sets the time to return to the [Base notch].

When  (Boost) or  (Purge) is selected on the «Main display» screen, the fan speed will return to the [Base Notch] automatically after a certain period of time.

During the Boost/Purge preset, appear icon  in «Main display» screen.

The Base notch is set to fan speed 1  at the factory default setting.

Button operation

1

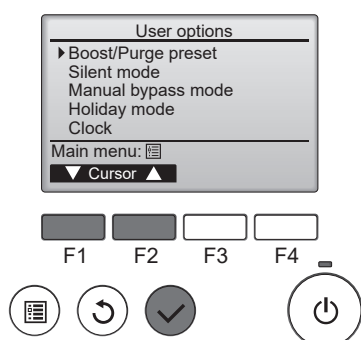

Select Boost/Purge preset from «User options» screen, and press the  button.

2

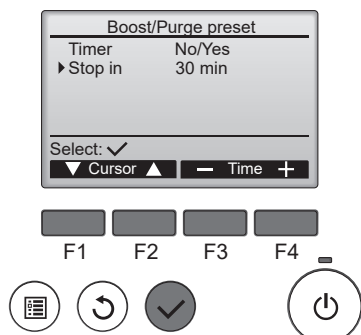

[Timer]: Select [Yes] or [No].

[No]: You can set no time limit.

[Yes]: You can use [Stop in] operation.

[Stop in]: Time can be selected from 10, 20, 30, ... 170, 180 min.

The factory default setting: 30 min

Silent mode

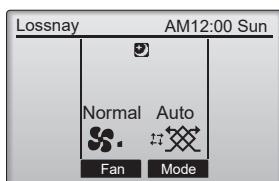

The Silent mode is an effective mode for noise prevention at night.

During the Silent mode,  icon will appear on the «Main display» screen.

Note

Under the Silent mode, the signal from the external input and operates are not received.

Button operation

1

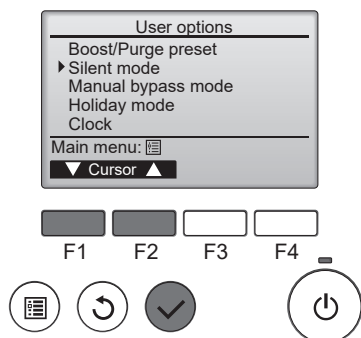

Select [Silent mode] from «User options» screen, and press the  button.

2

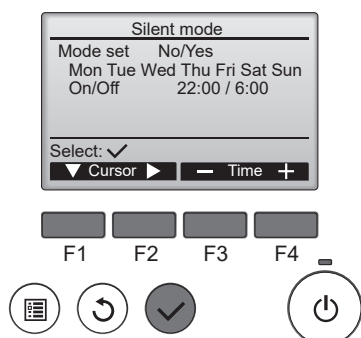

[Mode set]: Select [Yes] or [No].

The factory default setting: *No*

[Yes]: You can set day.

[On/Off]: You can set the time during day.

Manual bypass mode

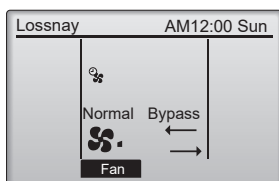

At the factory default settings, the Bypass mode cannot be selected on the «Main display». Use the Manual bypass mode at any timing to operate the Bypass mode.

During the Manual bypass mode,  icon is displayed on the «Main display».

The Manual bypass mode ends after the specified time.

Note

If outdoor temperature is below 8°C, the ventilation mode will not change to the Bypass.

Button operation

1

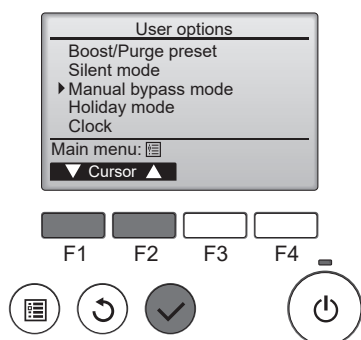

Setting method of the Manual bypass mode.

Select [Manual bypass mode] from the «User options» screen.

2

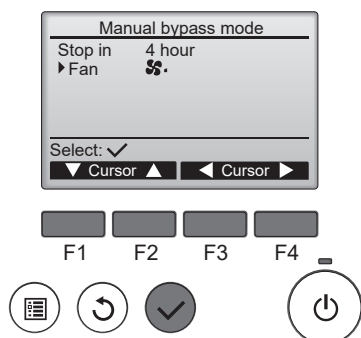

You can set the operation time of the Manual bypass mode.

[Stop in]: Time can be selected from 1, 2, ... 11, 12 hour.

[Fan]: You can select Fan speed of the Manual bypass mode.

The factory default settings: 4 hour and Fan speed is [Base notch].

Holiday mode

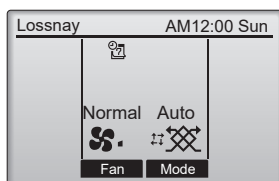









The Holiday mode is used when you are away from home for a long time.

 icon will appear on the «Main display».

The product starts the operation at the fan speed of the base notch.

 and  will operate at 50% of the airflow.

	Holiday mode
	ON
	 × 50%
	 × 50%
	 × 100%
	 × 100%

Button operation

1

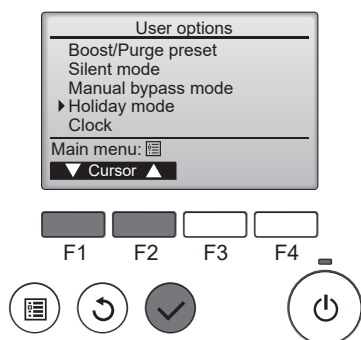

Select [Holiday mode] from «User options» screen, and press the  button.

2

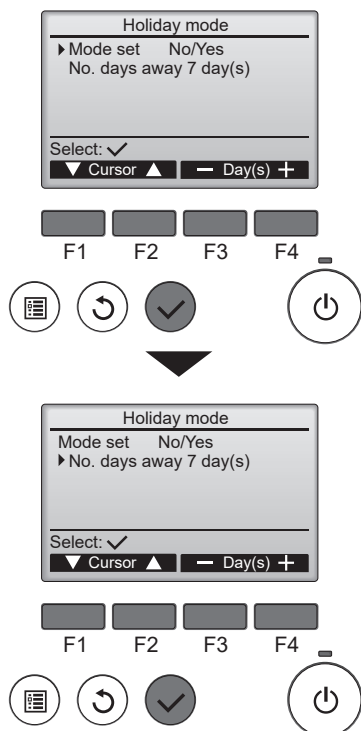

[Mode set]: Select [Yes] / [No].

The factory default setting: *No*

[Yes]: You can set day when you are not in house.

[No. days away]: Day can be selected from 1, 2, ... 89, 90 day(s)

After pressing the  button the Holiday mode starts.

Filter information

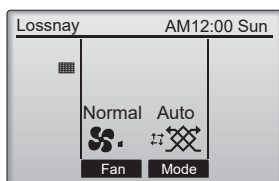

When this sign  appears, clean or replace the filters.

See section 6 about the cleaning the filters.

Note

The sign is displayed after the specified fan operation time.
The sign is set by the contractor according to the Installation Manual.
See Installation Manual section 6.4.11 for details.

Button operation

1

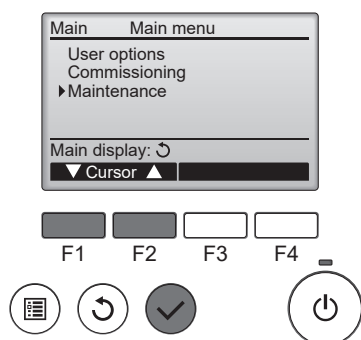

Select [Maintenance] from «Main menu» screen, and press the  button.

2

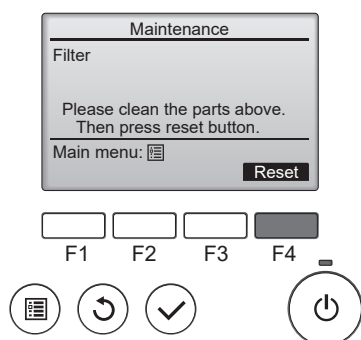

Press the [F4] button to reset cleaning sign.
See section 6 to clean the filters.

When using optional filters, clean or replace them following the their instructions.

3



Press the [F4] button to select [OK].

4

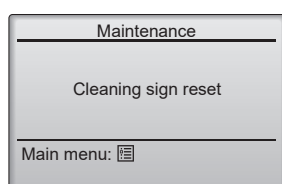

A confirmation screen will appear.

Error information

When an error occurs, the following screen will appear.
Check the error status, stop the product, and consult your dealer.

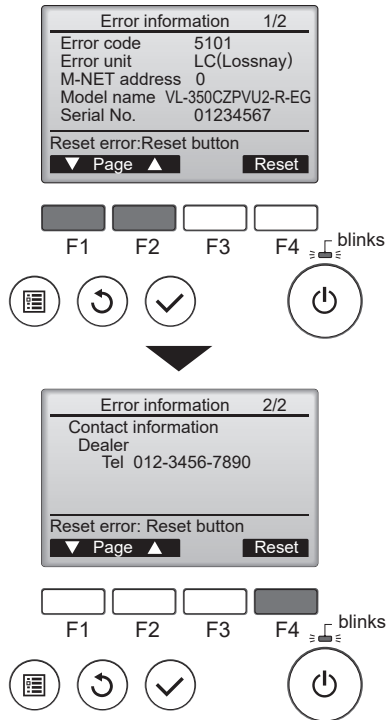

Error code, error unit, unit model name, and serial number will appear.

The model name and serial number will appear only if the information have been registered.

Press the **F1** or **F2** button to go to the next screen.

Contact information (dealer's phone number) will appear if the information have been registered.

Press the **F4** button to reset the error information.

6. Maintenance * The figure shows R-type.

Care of filters

Replace air filters at regular intervals in order to prevent a deterioration in the functions.

Filters are disposable.

Replacement interval is 1 year.

Replacement interval is different depending on the conditions of the air to use.

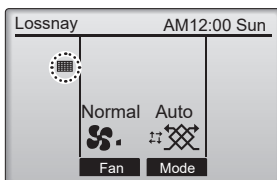

 will appear on the «Main display» when the filter needs to be replaced. The sign is set by the contractor according to the Installation Manual.

WARNING

Make sure to turn off the isolator before cleaning and maintenance.

Failure to heed this warning may result in electric shock or injury.

CAUTION

Wear gloves during cleaning and maintenance.

Failure to wear gloves may result in injury.

During cleaning and maintenance, do not climb on an unstable stand.

Injury may result if you tumble down.

- 1) Turn off the isolator on the power board before removing filters.

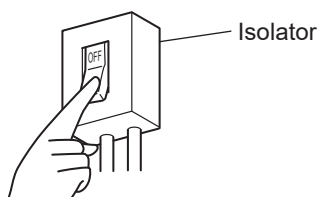

- 2) Remove the filter cover (outdoor air filter and exhaust air filter).

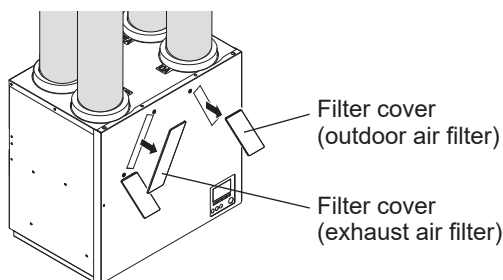

- 3) Gently draw out the outdoor air filter case and the exhaust air filter case.

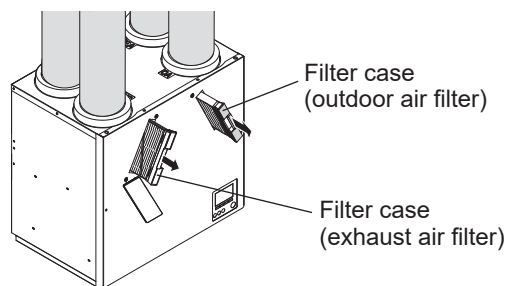

CAUTION

When removing the outdoor air filter case and exhaust filter case, dew condensation water that has built up indoors sometimes drips. So, remove the filter cases gently by supporting them with both hands so that they are not tilted.

- 4) Remove the air filters from the outdoor air filter case and the exhaust air filter case.

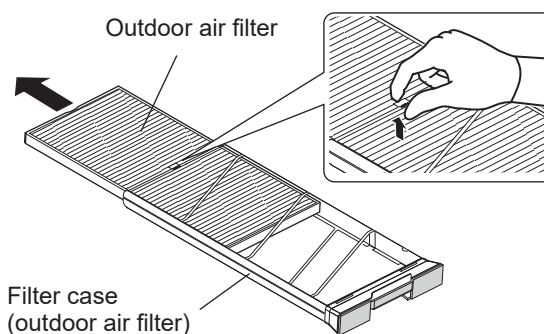

Note

- After replacing the filters, dispose of the used outdoor air filters and exhaust air filters for in accordance with disposal methods designated in the region where you live.

Outdoor air filters and exhaust air filters are made of polypropylene and polyester.

How to replace filters (sold separately)

Remove the outdoor air filters or exhaust air filters, and install new filters (sold separately).

Note

- **Make sure to install filters in the filter case before installing the filter case on the product.**
- **Do not mix up outdoor air filters and exhaust air filters.**

Assembling and checking after cleaning and maintenance

CAUTION

Securely install parts after cleaning and maintenance.

Injury could result if parts fall.

The filters' catch efficiency drops.

1. Install the filter on the filter case by following the disassembly procedure in reverse.
 - Make sure that the filter is not protruded from the filter case.

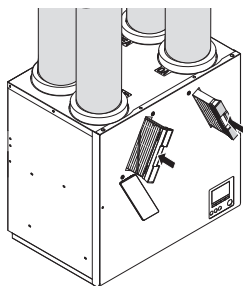

2. Install the outdoor air filter case and then install the filter cover.
3. Install the exhaust air filter case and then install the filter cover.
4. When you have finished assembling all, turn on the isolater and check followings,
 - Check for emission of abnormal noise.
 - Check for normal air flow.
 - Check for air leakage from the installation section of the outdoor air filter case or exhaust air filter case.
5. Reset the filter cleaning sign.
 - For details on how to reset the filter cleaning sign, see section 5. *Filter information*.

Note

- **In some operating environments, dew condensation water or snow/mist water droplets may adhere to the filters. This, however, is not a problem in product performance or quality.**
- **Do not forget to install the filters inside the product. (Doing so results in dirt clogging the surface of the heat exchanger or a drop in air volume.)**



Care of the controller

- To remove dirt from the controller's display, wipe with a cloth to which detergent has been applied: and then wipe with a dry cloth to remove any remaining detergent.
- Do not use the following solvents. (They will change the quality and color.)
- Paint thinner, alcohol, benzene, gasoline, kerosene, spray cleaner, cleaning alkali, etc.







7. Troubleshooting

Take the following actions if trouble shown in the table below occurs.

If trouble is not corrected even after taking the required action, or if trouble other than that indicated in the following table occurs, turn OFF the isolator, and then contact your dealer or an electrical contractor.

Symptom	Cause	Action
No operation	Power is not supplied to the product.	Check the circuit breaker on the power board.
	The  button on the controller is not [ON].	Press the  button on the controller to turn on.
There is a sound from the product	The sound of fans moving and the sound of winds flowing.	It is not a malfunction.
Operating noise has increased	The filter is not installed securely.	Re-install the filter. (see section 6.)
	The filter is clogged.	Exchange the filter. (see section 6.)
	The outdoor hood is blocked.	Remove obstacles.
Air flow has reduced	The filter is clogged.	Exchange the filter. (see section 6.)
Burbling noise from the product	Dew condensation water in the drain pipes is sucked into the wind taken in by the product but is not being discharged.	Reduce the fan speed of the product. The noise will disappear as it becomes easier to discharge the dew condensation water in the drain pipes.
Noise fluctuates	Noise sometimes gets louder because of the influence of outdoor wind. This is not a malfunction.	If you are worried about sound fluctuation, contact your dealer or an electrical contractor.
Dew condensation water in the filter case	Dew condensation water sometimes builds up in some operating environments.	It is not a malfunction.
The volume of the operating noise is different in different rooms	The volume of the noise sometimes differs, for example, because of the length of the piping to each room.	It is not a malfunction.
During winter season, Sometimes supply air stops.	The product is operating in the supply air intermittent mode.	It is not a malfunction. See <i>Automatic supply air stop function/Automatic supply air intermittent operation function</i> . (see next page.)
Supply air flow is cold	The outdoor air temperature is low.	It is not a malfunction. Supply air sometimes is cooled by the outdoor air.
Condensation occurs on the outside of the product.	If the outdoor temperature is low or the indoor humidity is high, condensation can occur outside the product.	It is not a malfunction. Remove the condensation with a cloth.
Inside the product or the filters are wet.	Inside the product or the filters can become wet due to fog outdoor or condensation.	It is not a malfunction.
Condensation occurs on the outlet of the supply air vent.	If the outdoor or indoor humidity is high, condensation can occur.	It is not a malfunction. Remove the condensation with a cloth.
The air volume increases/decreases without any command.	The air volume can increase/decrease automatically if the product receives external input.	It is not a malfunction. Check the setting.
The filter maintenance sign does not appear in appropriate time.	The sign is set by the contractor according to the Installation Manual. (The maintenance interval of the original filters is 1 year. Factory default setting is 6 months.)	It is not malfunction. Please reset the sign according to Section 5. Filter information. If you want to change the maintenance interval, contact your dealer or an electrical contractor.

When the controller is not working:

Symptom	Cause	Action
The OFF button does not function to stop the product.	The Enable OFF button is set to invalid. (At factory default settings, the Enable OFF button is set to No.)	It is not a malfunction. If the Enable OFF button is set, turn the isolator OFF to stop the product. To cancel the Enable OFF button setting, see 6.4.2.7 <i>Control mode</i> in the Installation Manual.
Ventilation mode (bypass, auto bypass) cannot be selected.	Due to the skip setting. (At factory default setting, the bypass ventilation is set to Skipped.)	It is not a malfunction. To cancel the skip setting, see 6.4.2.7 <i>Control mode</i> in the Installation Manual.
The fan speed ( ,  ,  , or ) cannot be selected.	Due to the skip setting. (At factory default setting,  is Skipped.)	It is not a malfunction. To cancel the skip setting, see 6.4.2.7 <i>Control mode</i> in the Installation Manual.
The air volume is changed without any command.	To protect the Heat exchanger from frost in winter, the air volume can increase/decrease.	It is not a malfunction.
	The air volume can increase/decrease automatically if the product receives external input.	
The air volume is not changed even when the product fan speed is changed.	When receiving the external input, the priority is given to it even when the lower fan speed is selected. (External input icon  is displayed if the fan speed is determined by the external input.)	It is not a malfunction.

Automatic supply air stop function/Automatic supply air intermittent operation function

To protect the Heat exchanger from frost, the product runs the Automatic supply air stop operation/ Automatic supply air intermittent operation when the outdoor air temperature is $-3\text{ }^{\circ}\text{C}$ or lower. To prevent frost from adhering to Heat exchanger, the supply air fan is controlled according to the temperatures below.

Outdoor temperature	$-15\text{ }^{\circ}\text{C}$ or lower	Between -15°C and -3°C	-3°C or higher
Mode	Supply air stop mode	Supply air intermittent operation	Continuous operation

Note

- Preheater (field supply) is recommended to maintain certain supply air and exhaust air.
- When the outdoor air temperature is $-15\text{ }^{\circ}\text{C}$ or lower, the supply air fan run to detect the outdoor air temperature.
- When the outdoor air temperature is -25°C or lower, the supply air fan does not run for the detection of the outdoor air temperature.

8. Specifications

Model	VL-250CZPVU2-R-EG VL-250CZPVU2-L-EG	VL-350CZPVU2-R-EG VL-350CZPVU2-L-EG	VL-500CZPVU2-R-EG VL-500CZPVU2-L-EG										
Electrical power supply	220-240 V / 50 Hz , 220 V / 60 Hz												
Erp Class	A ⁺												
Ventilation mode	Heat recovery mode												
Fan speed	4	3	2	1	4	3	2	1	4	3	2	1	
Fan speed icon													
Fan power	100%	70%	50%	30%	100%	70%	50%	30%	100%	70%	50%	30%	
Input power	[W]	107.5	44.5	23.5	12.5	138	63	34	19	255	104	49	21.5
Air volume	[m ³ /h]	235	165	114	68	280	200	140	90	450	305	210	120
	[L/s]	65.3	45.8	31.7	18.9	77.8	55.6	38.9	25.0	125.0	84.7	58.3	33.3
External static pressure [Pa]	150	74	38	14	150	74	38	14	200	98	50	18	
Temperature exchange efficiency [%]	85	87	88	90	85	87	88	90	85	87	89	92	
Noise (Sound pressure level * ¹) [dB]	31	22.5	16	15>	35	26	20	15>	37	29	22	15>	
Weight [kg]	25				32				39				

- The above values are at factory default setting.
- The current, power consumption, efficiency, and noise are measured at the rated air volume and at 230 V / 50 Hz.
- Contact your dealer for other specifications.

*¹ The sound pressure level at 3 m is spherical.

The sound pressure level is calculated using the sound power level.

The sound power level measurement is performed according to ISO3744 with hemi-anechoic chamber.

9. After-Sales Service

Consult with your dealer about the after-sales services provided for the product.

If you hear strange noise, if no air is blown out or if some other trouble occurs, turn off the power and contact your dealer. Consult with your dealer concerning the cost of inspection or repair work.

■ Retention period of functional repair parts

We will retain the functional repair parts for 6 years after terminating production of the product.

The functional repair part means a part which is necessary to maintain the function of the product.

■ Recommended inspection and maintenance

After several years of use, the following might occur. We recommend inspection and maintenance by a professional.

- Water leakage due to clogging of drain pipe and drain hose
- Entry of dust due to deterioration of filters
- Abnormal noise or vibration due to the motor reaching the end of its service life
- Air leakage due to the heat exchanger reaching the end of its service life

The following are consumables:

- Motor
- Outdoor air filter
- Exhaust air filter
- Heat exchanger

■ Repair costs include technical fee, cost of parts, (and business trip charges), etc.